

**2001–2013 TRUCK CHILD PASSENGER SAFETY
SUPPLEMENT**

Dodge/Ram



FIAT CHRYSLER AUTOMOBILES

©2016 FCA US LLC. All Rights Reserved.

Dodge and Ram are registered trademarks of FCA US LLC.

TABLE OF CONTENTS

1	INTRODUCTION	2
2	INSTALLING CHILD RESTRAINTS	4
3	INSTALLING CHILD RESTRAINTS IN YOUR VEHICLE — DODGE	9
4	INSTALLING CHILD RESTRAINTS IN YOUR VEHICLE — RAM	50
5	INDEX	69

INTRODUCTION

CONTENTS

- Welcome From FCA US LLC.3
- How To Use This Supplement.3

Welcome From FCA US LLC

If you have opened this guide, chances are you have questions about the correct use of child restraints in your vehicle. This supplement has been developed to help answer those questions. This document is intended to supplement the information provided in the Owner's Manual and/or User Guide that came with your vehicle. If you no longer have your Owner's Manual or User Guide, please visit www.techauthority.com to order a replacement.

This guide does not cover the proper selection of car seats or the proper usage of car seats.

For questions about car seat selection and usage, please visit NHTSA's website: <http://www.safercar.gov/parents/Car-Seat-Safety.htm>.

NOTE: This website also features videos showing step-by-step installation of different types of car seats.

How To Use This Supplement

The first chapter of this supplement, "Installing Child Restraints," provides general information about the installation of child restraints in vehicles. It provides step-by-step instructions for installing a car seat using either the seat belts or the LATCH anchorages in your vehicle. Read this section to learn how to:

- Locate LATCH and Tether anchorages in vehicles
- Install a car seat using LATCH
- Install a car seat using seat belts

This section also includes key warnings about the misuse of car seats. Read and follow all of these warnings when transporting children in your vehicle.

The remaining chapters provide information that is specific for the Brand, Model and Model Year of your vehicle. To use this section, first refer to the table of contents to find your vehicle. Some listings will include a range of model years. Click on the section for your vehicle to find information about:

- Locating the LATCH anchorages in your vehicle
- Frequently asked questions about LATCH
- Directions for locating and using the Tether Anchorages in your vehicle
- Seat belt systems in your vehicle for installing car seats
- Frequently asked questions about seat belts and car seats

Copyright ©2016 FCA US LLC

INSTALLING CHILD RESTRAINTS

CONTENTS

■ Installing Child Restraints	5	■ How To Stow An Unused ALR Seat Belt	7
■ Rear-Facing Car Seats And Air Bags	5	■ Installing Child Restraints Using The Vehicle Seat Belt	7
■ Passenger Air Bag Disable (PAD) Indicator Light — If Equipped.	5	■ Installing A Child Restraint With A Switchable Automatic Locking Retractor (ALR) — If Equipped . . .	7
■ Passenger Airbag On/Off Switch – If Equipped	5	■ Installing A Child Restraint With A Cinching Latch Plate (CINCH) — If Equipped	7
■ Lower Anchors And Tethers For Children (LATCH) Restraint System	6	■ Installing Child Restraints Using The Top Tether Anchorage	8
■ Locating The LATCH And Tether Anchorages	6		
■ Installing Child Restraints Using The LATCH Lower Anchorages	6		

Installing Child Restraints

Children 12 years or younger should ride properly buckled up in a rear seat, if available. According to crash statistics, children are safer when properly restrained in the rear seats rather than in the front.

Every state in the United States and all Canadian provinces require that small children ride in proper restraint systems. This is the law, and you can be prosecuted for ignoring it.

NOTE: For additional information, refer to www.seatcheck.org or call 1-866-SEATCHECK. Canadian residents should refer to Transport Canada’s website for additional information: <http://www.tc.gc.ca/eng/motorvehiclesafety/safedrivers-childsafety-index-53.htm>

Rear-Facing Car Seats And Air Bags

WARNING!

- Never place a rear-facing child restraint in front of an air bag. A deploying passenger Advanced Front Air Bag can cause death or serious injury to a child 12 years or younger, including a child in a rear-facing child restraint.
- Only use a rear-facing child restraint in a vehicle with a rear seat.

Passenger Air Bag Disable (PAD) Indicator Light — If Equipped

The PAD is an amber light located in the instrument panel which tells the driver and front passenger when the front passenger air bag is turned off. The PAD indicator light illuminates to show that the passenger air bag will not inflate during a collision requiring air bags. The PAD light will illuminate when the passenger frontal air bag has been turned off by using the manual ON/OFF switch. Refer to your Owner’s Manual for additional information.

Passenger Airbag On/Off Switch – If Equipped

See your vehicle owner’s manual for instructions for turning this switch on and off. The passenger front airbag is to be turned off only if the passenger:

- is an infant (less than 1 year old) who must ride in the front seat because there is no rear seat, because the rear seat is too small for a rear-facing infant restraint or because the infant has a medical condition which makes it necessary for the driver to be able to see the infant,
- is a child, age 1 to 12 who must ride in the front seat because there is no rear seat, because there is no rear seat position available, or because the child has a medical condition which makes it necessary for the driver to be able to see the child,

- has a medical condition which makes passenger airbag inflation (deployment) a greater risk for the passenger than the risk of hitting the dashboard (instrument panel) or windshield in a crash.



Dodge Dakota – 2001-2004 (All Cabs)

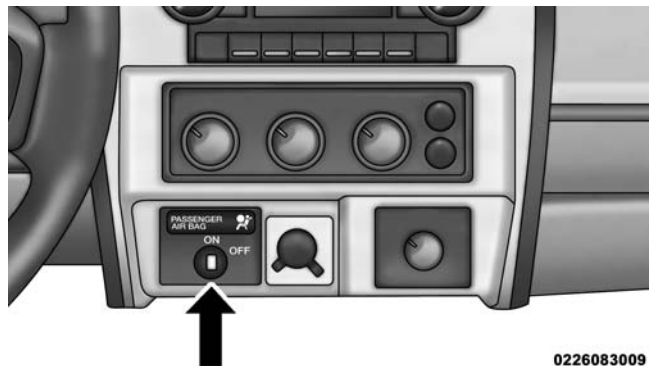

Dodge Dakota – 2005-2007 (Club Cab Only)

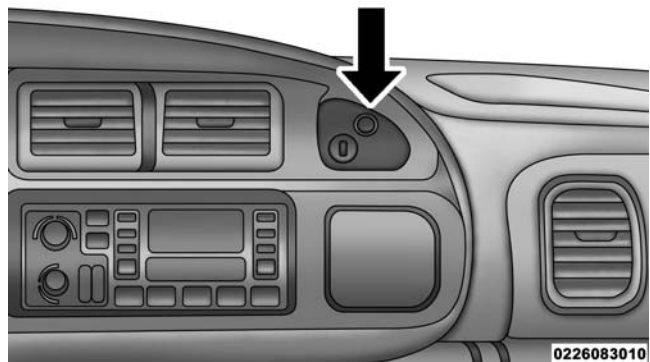

All Cabs for the Following Vehicles:

- Dodge Ram 1500 – 2001 Model Year
- Dodge Ram 2500/3500 – 2001-2002 Model Years



Regular Cab Only for the following Vehicles:

- Dodge Ram 1500 – 2002-2007 Model Years
- Dodge Ram 2500/3500 – 2003-2009 Model Years
- Dodge Ram Chassis Cab 3500/4500/5500 – 2003-2009 Model Years

Lower Anchors And Tethers For Children (LATCH) Restraint System



022668173

Your vehicle is equipped with the child restraint anchorage system called LATCH, which stands for Lower Anchors and Tethers for Children. The LATCH system has three vehicle anchor points for installing LATCH-equipped child seats. There are two lower anchorages located at the back of the seat cushion where it meets the seatback and one top tether anchorage located behind the seating position. These anchorages are used to install LATCH-equipped child seats without using the vehicle's seat belts. Some seating positions may have a top tether anchorage but no lower anchorages. In these seating positions, the seat belt must be used with the top tether anchorage to install the child restraint.

NOTE: The LATCH system was phased into vehicles during the 2000–2002 model years. Certain 2001 and 2002 model year trucks did not feature lower anchorages. These vehicles had tether anchorages only. See the section “LATCH and Tethers in Your Vehicle” for more information.

Locating The LATCH And Tether Anchorages

The lower anchorages are round bars that are found at the rear of the seat cushion where it meets the seatback. If the bars are not readily visible, they are located below the anchorage symbols on the seatback (if equipped). You will easily feel them if you run your finger along the gap between the seatback and seat cushion.



There are tether strap anchorages behind most rear seating positions. See the section “LATCH and Tethers in Your Vehicle” for more information about finding tethers in your vehicle, as they may be located on the back of the seat, on the floor or in the roof. Some may be hidden behind a panel or cover.

Always follow the directions of the child restraint manufacturer when installing your child restraint. Not all child restraint systems will be installed as described here.

Installing Child Restraints Using The LATCH Lower Anchorages

1. If the selected seating position has a Switchable Automatic Locking Retractor (ALR) seat belt, stow the seat belt, following the instructions below. See the section “Seat Belt Systems in Your Vehicle” to check what type of seat belt each seating position has.
2. Loosen the adjusters on the lower straps and on the tether strap of the child seat so that you can more easily attach the hooks or connectors to the vehicle anchorages.
3. Place the child seat between the lower anchorages for that seating position. For some second row seats, you may need to recline the seat and/or raise the head restraint to get a better fit. If the rear seat can be moved forward and rearward in the vehicle, you may wish to move it to its rear-most position to make room for the child seat. You may also move the front seat forward to allow more room for the child seat.
4. Attach the lower hooks or connectors of the child restraint to the lower anchorages in the selected seating position.
5. If the child restraint has a tether strap, connect it to the top tether anchorage. See the section “LATCH and Tethers in Your Vehicle” for directions to attach a tether anchor.
6. Tighten all of the straps as you push the child restraint rearward and downward into the seat. Remove slack in the straps according to the child restraint manufacturer's instructions.
7. Test that the child restraint is installed tightly by pulling back and forth on the child seat at the belt path. It should not move more than 1 inch (25.4 mm) in any direction.

How To Stow An Unused ALR Seat Belt

When using the LATCH attaching system to install a child restraint, stow all ALR seat belts that are not being used by other occupants or being used to secure child restraints. An unused belt could injure a child if they play with it and accidentally lock the seat belt retractor. Before installing a child restraint using the LATCH system, buckle the seat belt behind the child restraint and out of the child's reach. If the buckled seat belt interferes with the child restraint installation, instead of buckling it behind the child restraint, route the seat belt through the child restraint belt path and then buckle it. Do not lock the seat belt. Remind all children in the vehicle that the seat belts are not toys and that they should not play with them.

WARNING!

- **Improper installation of a child restraint to the LATCH anchorages can lead to failure of the restraint. The child could be badly injured or killed. Follow the child restraint manufacturer's directions exactly when installing an infant or child restraint.**
- **Child restraint anchorages are designed to withstand only those loads imposed by correctly-fitted child restraints. Under no circumstances are they to be used for adult seat belts, harnesses, or for attaching other items or equipment to the vehicle.**

Installing Child Restraints Using The Vehicle Seat Belt

The seat belts in the passenger seating positions are equipped with either a Switchable Automatic Locking Retractor (ALR) or a cinching latch plate or both. Both types of seat belts are designed to keep the lap portion of the seat belt tight around the child restraint so that it is not necessary to use a locking clip.

The ALR retractor can be "switched" into a locked mode by pulling all of the webbing out of the retractor and then letting the webbing retract back into the retractor. If it is locked, the ALR will make a clicking noise while the webbing is pulled back into the retractor. For additional information on ALR, refer to the section "Seat Belt Systems in Your Vehicle." The cinching latch plate is designed to hold the lap portion of the seat belt tight when webbing is pulled tight and straight through a child restraint's belt path.

When installing a forward-facing child restraint, always use the tether anchor up to the maximum weight allowed. See the section "LATCH and Tethers in Your Vehicle" for more information about LATCH weight limits.

Installing A Child Restraint With A Switchable Automatic Locking Retractor (ALR) — If Equipped

1. Place the child seat in the center of the seating position. For some second row seats, you may need to recline the seat and/or raise the head restraint to get a better fit. If the rear seat can be moved forward and rearward in the

vehicle, you may wish to move it to its rear-most position to make room for the child seat. You may also move the front seat forward to allow more room for the child seat.

2. Pull enough of the seat belt webbing from the retractor to pass it through the belt path of the child restraint. Do not twist the belt webbing in the belt path.
3. Slide the latch plate into the buckle until you hear a "click."
4. Pull on the webbing to make the lap portion tight against the child seat.
5. To lock the seat belt, pull down on the shoulder part of the belt until you have pulled all the seat belt webbing out of the retractor. Then, allow the webbing to retract back into the retractor. As the webbing retracts, you will hear a clicking sound. This means the seat belt is now in the Automatic Locking mode.
6. Try to pull the webbing out of the retractor. If it is locked, you should not be able to pull out any webbing. If the retractor is **not** locked, repeat step 5.
7. Finally, pull up on any excess webbing to tighten the lap portion around the child restraint while you push the child restraint rearward and downward into the vehicle seat.
8. If the child restraint has a top tether strap and the seating position has a top tether anchorage, connect the tether strap to the anchorage and tighten the tether strap. See the section "LATCH and Tethers in Your Vehicle" for directions to attach a tether anchor.
9. Test that the child restraint is installed tightly by pulling back and forth on the child seat at the belt path. It should not move more than 1 inch (25.4 mm) in any direction.

Any seat belt system will loosen with time, so check the belt occasionally, and pull it tight if necessary.

WARNING!

Do not use the Automatic Locking Mode to restrain occupants who are wearing the seat belt or children who are using booster seats. The locked mode is only used to install rear-facing or forward-facing child restraints that have a harness for restraining the child.

Installing A Child Restraint With A Cinching Latch Plate (CINCH) — If Equipped

1. Place the child seat in the center of the seating position. For some second row seats, you may need to recline the seat and/or raise the head restraint to get a better fit. If the rear seat can be moved forward and rearward in the vehicle, you may wish to move it to its rear-most position to make room for the child seat. You may also move the front seat forward to allow more room for the child seat.
2. Next, pull enough of the seat belt webbing from the retractor to pass it through the belt path of the child restraint. Do not twist the belt webbing in the belt path.

8 INSTALLING CHILD RESTRAINTS

- Slide the latch plate into the buckle until you hear a "click."
- Finally, pull up on any excess webbing to tighten the lap portion around the child restraint while you push the child restraint rearward and downward into the vehicle seat.
- If the child restraint has a top tether strap and the seating position has a top tether anchorage, connect the tether strap to the anchorage and tighten the tether strap. See the section "LATCH and Tethers in Your Vehicle" for directions to attach a tether anchor.
- Test that the child restraint is installed tightly by pulling back and forth on the child seat at the belt path. It should not move more than 1 inch (25.4 mm) in any direction.

Any seat belt system will loosen with time, so check the belt occasionally, and pull it tight if necessary.

If the buckle or the cinching latch plate is too close to the belt path opening of the child restraint, you may have trouble tightening the seat belt. If this happens, disconnect the latch plate from the buckle and twist the short buckle-end belt up to three full turns to shorten it. Insert the latch plate into the buckle with the release button facing out, away from the child restraint. Repeat steps 4 to 6, above, to complete the installation of the child restraint.

If the belt still cannot be tightened after you shorten the buckle, disconnect the latch plate from the buckle, turn the buckle around one half turn, and insert the latch plate into the buckle again. If you still cannot make the child restraint installation tight, try a different seating position.

Installing Child Restraints Using The Top Tether Anchorage

See the section "LATCH and Tethers in Your Vehicle" for specific instructions for using the tether anchorages in your vehicle.

WARNING!

Do not attach a tether strap for a rear-facing car seat to any location in front of the car seat, including the seat frame or a tether anchorage. Only attach the tether strap of a rear-facing car seat to the tether anchorage that is approved for that seating position, located behind the top of the vehicle seat. See the section "LATCH and Tethers in Your Vehicle" for the location of approved tether anchorages in your vehicle.

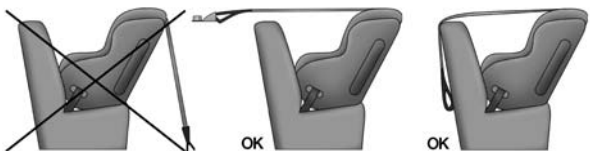

0226047162

WARNING!

- In a collision, an unrestrained child, even a tiny baby, can become a projectile inside the vehicle. The force required to hold even an infant on your lap could become so great that you could not hold the child, no matter how strong you are. The child and others could be severely injured or killed. Any child riding in your vehicle should be in a proper restraint for the child's size.
- Never place a rear-facing child restraint in front of an air bag. A deploying Passenger Advanced Front Air Bag can cause death or serious injury to a child 12 years or younger, including a child in a rear-facing child restraint.
- Only use a rear-facing child restraint in a vehicle with a rear seat.
- Improper installation of a child restraint to the LATCH anchorages can lead to failure of an infant or child restraint. The child could be severely injured or killed. Follow the manufacturer's directions exactly when installing an infant or child restraint.
- An incorrectly anchored tether strap could lead to increased head motion and possible injury to the child. Use only the anchor positions directly behind the child seat to secure a child restraint top tether strap.
- If your vehicle is equipped with a split rear seat, make sure the tether strap does not slip into the opening between the seatbacks as you remove slack in the strap.

WARNING!

If your vehicle is equipped with in-floor storage, do not install a rear-facing car seat using a rear support leg in this vehicle. The floor of this vehicle is not designed to manage the crash forces of this type of car seat. In a crash, the support leg may not function as it was designed by the car seat manufacturer, and your child may be more severely injured as a result.



0226047161

INSTALLING CHILD RESTRAINTS IN YOUR VEHICLE — DODGE

CONTENTS

■ DODGE DAKOTA, 2001–200410	□ Directions For Attaching The Tether Anchorage28
□ LATCH And Tethers In Your Vehicle10	□ Seat Belt Systems In Your Vehicle33
□ Center Seat LATCH13	■ DODGE RAM 2500/3500, 2001–200936
□ Directions For Attaching The Tether Anchorage13	□ LATCH And Tethers In Your Vehicle36
□ Seat Belt Systems In Your Vehicle15	□ Center Seat LATCH39
■ DODGE DAKOTA, 2005–201117	□ Directions For Attaching The Tether Anchorage39
□ LATCH And Tethers In Your Vehicle17	□ Seat Belt Systems In Your Vehicle42
□ Center Seat LATCH20	■ DODGE RAM CHASSIS CAB, 2007–201044
□ Directions For Attaching The Tether Anchorage20	□ LATCH And Tethers In Your Vehicle44
□ Seat Belt Systems In Your Vehicle22	□ Center Seat LATCH46
■ DODGE RAM 1500, 2001–200924	□ Directions For Attaching The Tether Anchorage46
□ LATCH And Tethers In Your Vehicle24	□ Seat Belt Systems In Your Vehicle48
□ Center Seat LATCH28		

DODGE DAKOTA, 2001–2004

LATCH And Tethers In Your Vehicle

LATCH Positions For Installing Child Restraints In This Vehicle

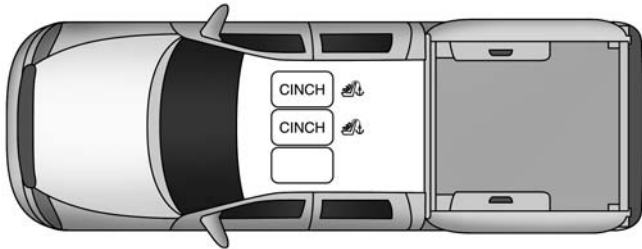

0226082982

Regular Cab (2001–2002 Model Years)

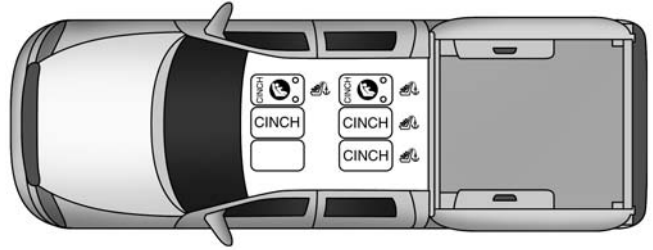

0226083890

Club Cab (2003–2004 Model Years)

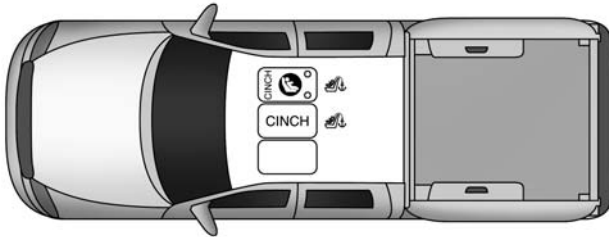

0226082986

Regular Cab (2003–2004 Model Years)

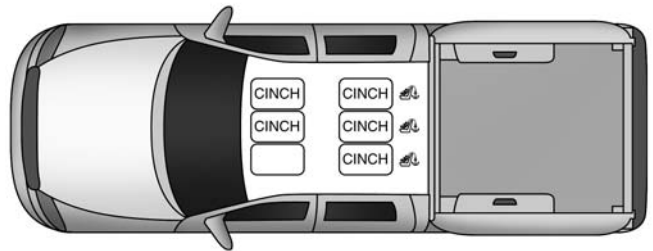

0226082981

Quad Cab (2001–2002 Model Years)

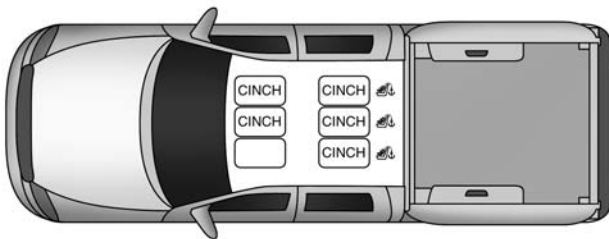

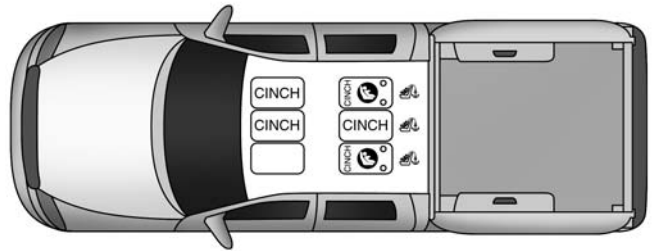

0226082981

Club Cab (2001–2002 Model Years)



0226082984

Quad Cab (2003–2004 Model Years)

- CINCH — Cinching Latch Plate
-  Lower Anchorage Symbol (2 Anchorages Per Seating Position)
-  Top Tether Anchorage Symbol

Locating The LATCH Lower Anchorages In This Vehicle

NOTE: 2001-2002 Dodge Dakota did not have lower anchorages.

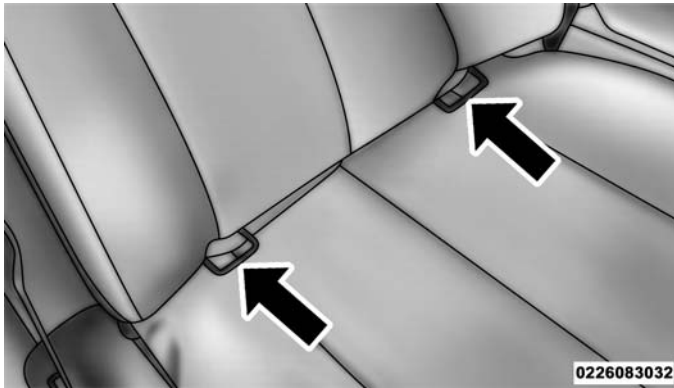

Standard and Club Cab Front Passenger Seat (2003-2004 Model Years)

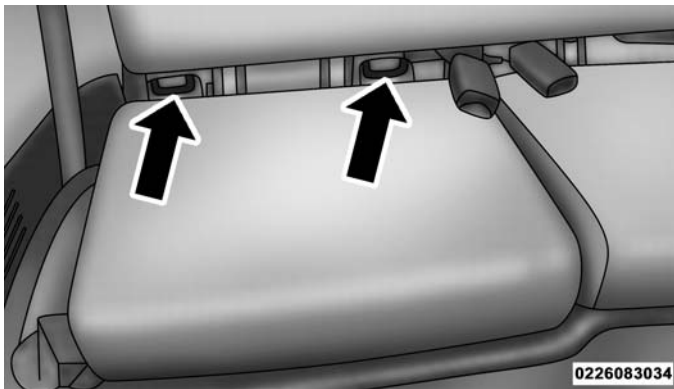

Club Cab Right Rear Seat (2003-2004 Model Years)



Quad Cab Rear Seat (2003-2004 Model Years)

Locating The Tether Anchorages In This Vehicle



Regular Cab models have two tether anchorages, one behind each passenger seating position (front center and right seat positions).

Club Cab and Quad Cab models have three anchorages, one behind each of the rear seat positions (rear left, center, and right seat positions).

2003-2004 Model Year Only: Club Cab models have an additional tether anchorage on the back of the front passenger seat.

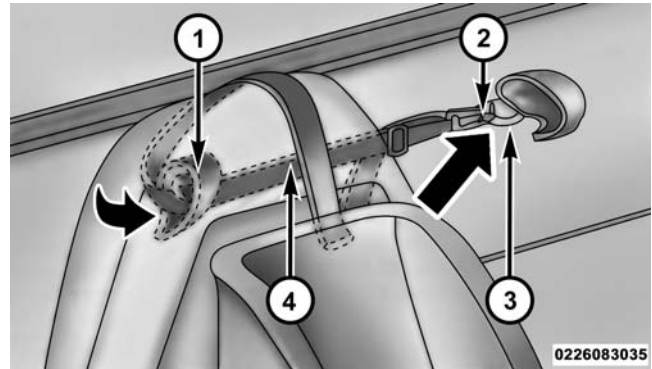

Regular Cab Front Passenger Seat (2001-2004 Model Years)

1. Anchor Strap Loop
2. Tether Strap Hook
3. Anchor Strap Metal Ring
4. Tether Strap

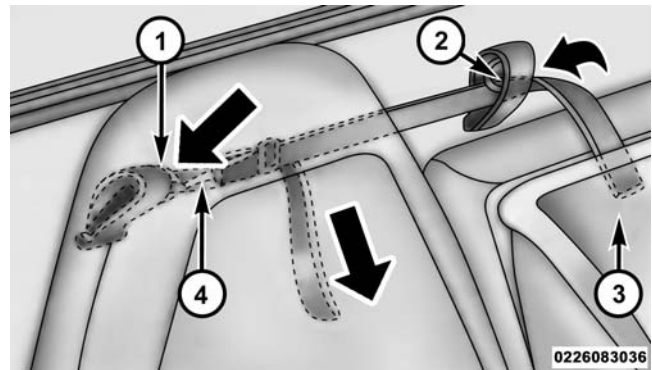

Regular Cab Center Seat – Bench Seat Only (2001-2004 Model Years)

1. Anchor Strap Metal Ring
2. Anchor Strap Loop
3. Child Seat
4. Tether Strap Hook

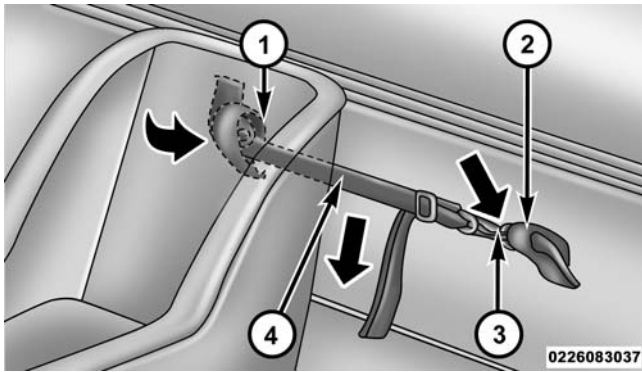

Club or Quad Cab Rear Seat (2001-2004 Model Years)



Club Cab Front Passenger Seat (2003-2004 Model Years)

1. Anchor Strap Loop
2. Anchor Strap Metal Ring
3. Tether Strap Hook
4. Tether Strap

Frequently Asked Questions About LATCH

What is the weight limit (child’s weight + weight of the child restraint) for using the LATCH anchorage system to attach the child restraint?	65 lbs (29.5 kg)	Use the LATCH anchorage system until the combined weight of the child and the child restraint is 65 lbs (29.5 kg). Use the seat belt alone instead of the LATCH anchorage system once the combined weight is more than 65 lbs (29.5 kg).
Can the LATCH anchorages and the seat belt be used together to attach a rear-facing or forward-facing child restraint?	No	Do not use the seat belt when you use the LATCH anchorage system to attach a rear-facing or forward-facing child restraint.
Can two child restraints be attached using a common lower LATCH anchorage?	No	Never “share” a LATCH anchorage with two or more child restraints. If the center position does not have dedicated LATCH lower anchorages, use the seat belt to install a child seat in the center position next to a child seat using the LATCH anchorages in an outboard position.
Can the rear-facing child restraint touch the back of the front passenger seat?	Yes	The child seat may touch the back of the front passenger seat if the child restraint manufacturer also allows contact. See your child restraint owner’s manual for more information.
Can the head restraints be removed?	No	
2003–2004 Quad Cab		
Can a child seat be installed in the center position using the inner LATCH lower anchorages?	No	Use the seat belt and tether anchor to install a child seat in the center seating position.

Center Seat LATCH

Quad Cab (2003–2004 Model Years)

WARNING!

- Do not install a child restraint in the center position using the LATCH system. This position is not approved for installing child seats using the LATCH attachments. You must use the seat belt and tether anchor to install a child seat in the center seating position.
- Never use the same lower anchorage to attach more than one child restraint. Please refer to "Installing Child Restraints Using the LATCH Lower Anchorages" in the section "Installing Child Restraints" for typical installation instructions.

Directions For Attaching The Tether Anchorage

Regular Cab (2001-2004 Model Years)

Front Passenger Seat - To attach the tether strap to the tether anchorage:

1. Place the child restraint on the front passenger seat.
2. Route the tether strap over the top of the seat.
3. Thread the tether strap through the anchor strap loop, located directly behind the passenger seat.
4. Route the tether strap across to the anchor strap loop installed behind the center seat.
5. Attach the tether strap hook of the child restraint to the anchor strap metal ring found inside the anchor strap loop behind the center seating position.
6. Remove slack in the tether strap according to the child restraint manufacturer's instructions.

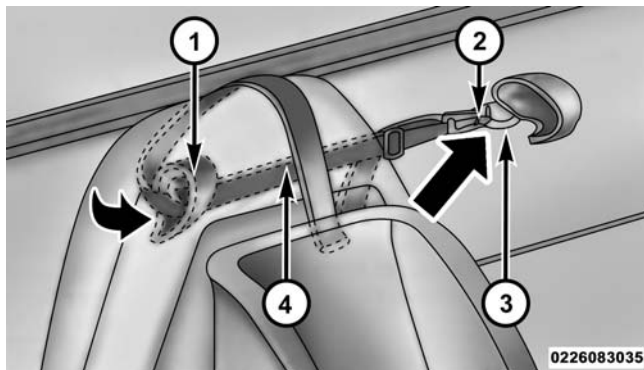

Regular Cab Front Passenger Seat (2001-2004 Model Years)

1. Anchor Strap Loop
2. Tether Strap Hook
3. Anchor Strap Metal Ring
4. Tether Strap

Front Center Seat - To attach the tether strap to the tether anchorage:

1. Place the child restraint on the front center seat.
2. Route the tether strap over the top of the seat.
3. Thread the tether strap through the anchor strap loop, located directly behind the center seat.
4. Route the tether strap across to the anchor strap loop installed behind the front passenger seat.
5. Attach the tether strap hook of the child restraint to the anchor strap metal ring found inside the anchor strap loop behind the front passenger seating position.
6. Remove slack in the tether strap according to the child restraint manufacturer's instructions.

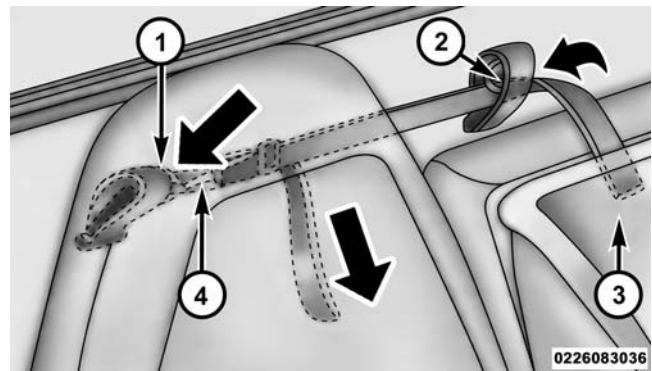

Regular Cab Center Seat – Bench Seat Only (2001-2004 Model Years)

1. Anchor Strap Metal Ring
2. Anchor Strap Loop
3. Child Seat
4. Tether Strap Hook

Club Cab Front Passenger Seat (2003-2004 Model Years)

1. Place the child restraint on the front passenger seat.
2. Route the tether strap over the top of the seat.
3. Attach the tether strap hook of the child restraint to the top tether anchorage as shown in the diagram.
4. Remove slack in the tether strap according to the child restraint manufacturer's instructions.



0226083038

Club Cab Front Passenger Seat (2003-2004 Model Years)

WARNING!

Never place a rear-facing child restraint in front of an air bag. A deploying passenger Front Air Bag can cause death or serious injury to a child 12 years or younger, including a child in a rear-facing child restraint.

Club Cab/Quad Cab Rear Seat (2001-2004 Model Years)

1. Route the child restraint tether strap through the anchor strap loop, located directly behind the child restraint.
2. Route the tether strap across to the next nearest installed anchor strap loop, and attach the tether strap hook to the anchor strap metal ring.
3. Remove the slack in the tether strap so that both anchor straps are pulled tight.

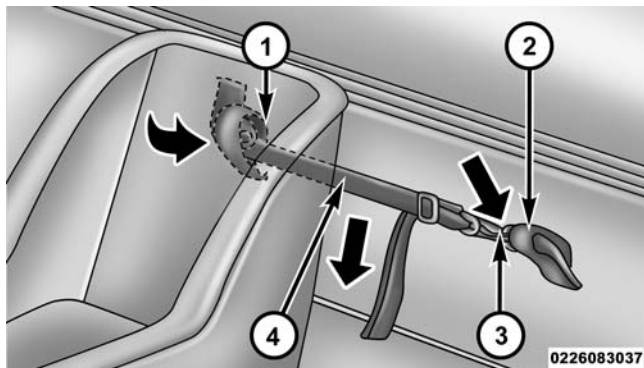

0226083037

Club Cab/Quad Cab Rear Seat (2001-2004 Model Years)

1. Anchor Strap Loop
2. Anchor Strap Metal Ring
3. Tether Strap Hook
4. Tether Strap

NOTE: Every Club Cab model has a cab-back panel with a flip-down door (padded bolster). The tether straps are located behind this door.

Multiple Child Restraint Installation Sequence – Club Cab/Quad Cab Rear Seat

1. Thread the child restraint tether strap hook through the anchor strap loop, located directly behind the child restraint.
2. After following step 1 for either of the two outer seats, route the tether strap hook to the metal ring on the anchor strap behind the center seat and attach the hook to the metal ring.
3. After following step 1 for the center child restraint, route the tether strap hook to the metal ring on the anchor strap loop, located behind the passenger's seat. Attach the tether strap hook to the anchor strap metal ring.

NOTE: Two Anchors must be used for each of the three seating positions as shown in the diagram.

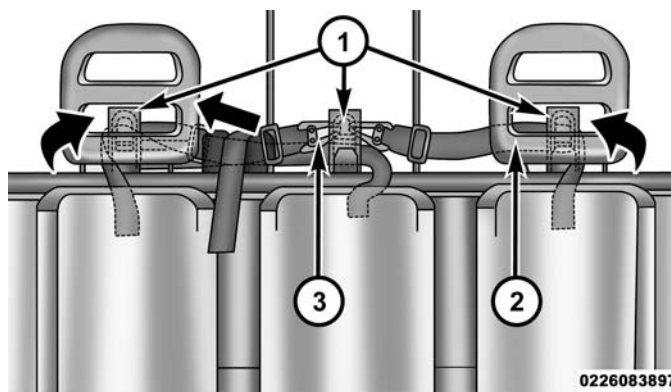

0226083897

Multiple Child Restraint Installation Sequence

1. Anchor Strap Metal Ring(s)
2. Tether Strap
3. Tether Strap Hook

Seat Belt Systems In Your Vehicle

Lap/Shoulder Belt Systems For Installing Child Restraints In This Vehicle

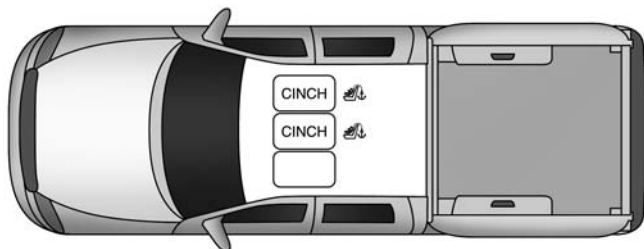

0226082982

Regular Cab (2001–2002 Model Years)

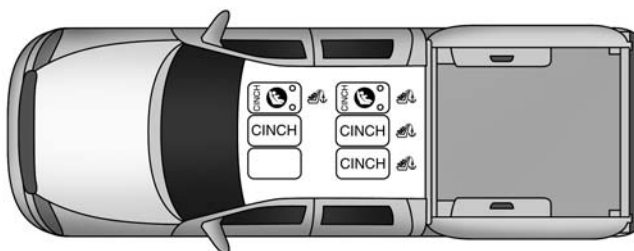

0226083890

Club Cab (2003–2004 Model Years)

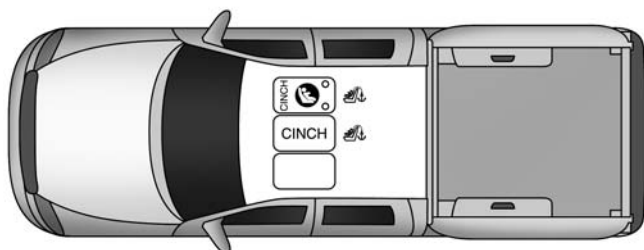

0226082986

Regular Cab (2003–2004 Model Years)

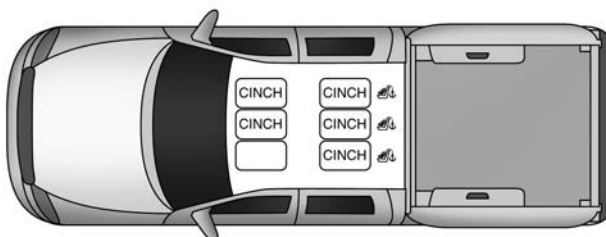

0226082981

Quad Cab (2001–2002 Model Years)

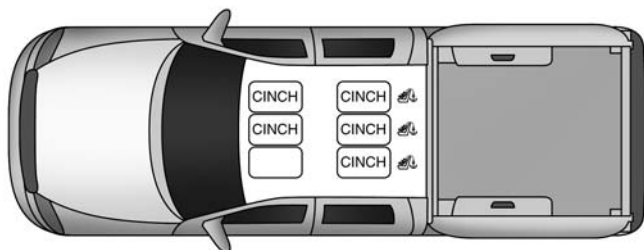

0226082981

Club Cab (2001–2002 Model Years)

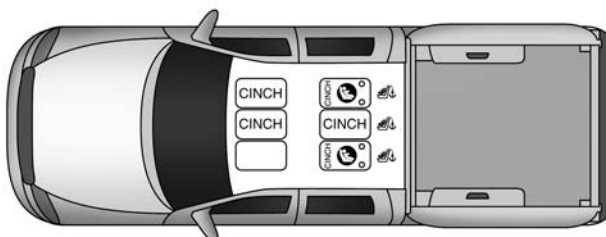

0226082984

Quad Cab (2003–2004 Model Years)

- CINCH — Cinching Latch Plate
- Lower Anchorage Symbol (2 Anchorages Per Seating Position)
- Top Tether Anchorage Symbol

Frequently Asked Questions About Seat Belts And Car Seats

What is the weight limit (child's weight + weight of the child restraint) for using the Tether Anchor with the seat belt to attach a forward facing child restraint?	65 lbs (29.5 kg)	The Tether Anchor can be used with the seat belt until the combined weight of the child and the child restraint is 65 lbs (29.5 kg). Use the seat belt without the Tether Anchor once the combined weight is more than 65 lbs (29.5 kg).
Can the rear-facing child restraint touch the back of the front passenger seat?	Yes	Contact between the front passenger seat and the child restraint is allowed, if the child restraint manufacturer also allows contact.
Can the head restraints be removed?	No	
Can the buckle stalk be twisted to tighten the seat belt against the belt path of the child restraint?	Yes	In positions with cinching latch plates (CINCH), the buckle stalk may be twisted up to 3 full turns. Do not twist the buckle stalk in a seating position with an ALR retractor.

DODGE DAKOTA, 2005–2011

LATCH And Tethers In Your Vehicle

LATCH Positions For Installing Child Restraints In This Vehicle

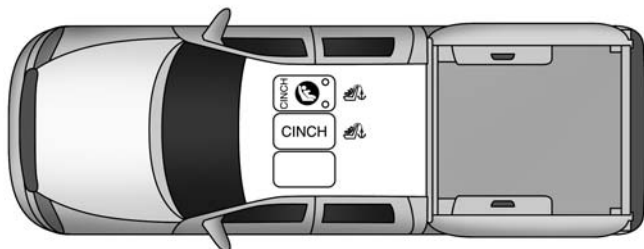

0226082986

No Rear Seat Club Cab (2005–2007 Model Years)

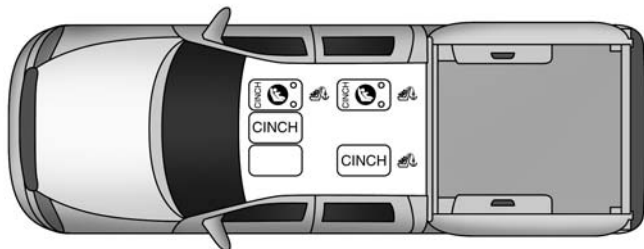

0226083891

Rear Jump Seat Club Cab (2005–2007 Model Years)

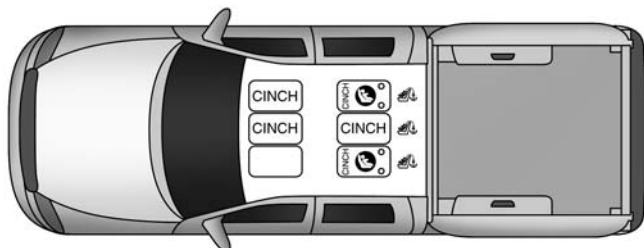

0226082990

Quad Cab (2005–2007 Model Years)

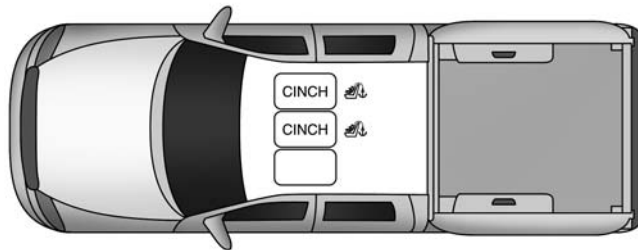

0226082991

No Rear Seat Extended Cab (2008–2011 Model Years)

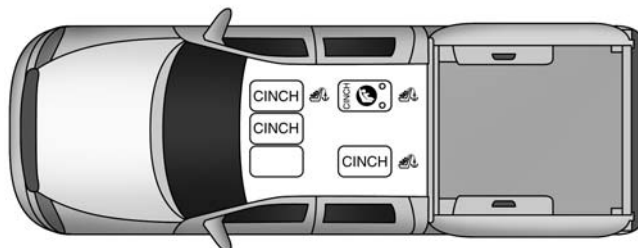

0226082993

Rear Jump Seat Extended Cab (2008–2011 Model Years)

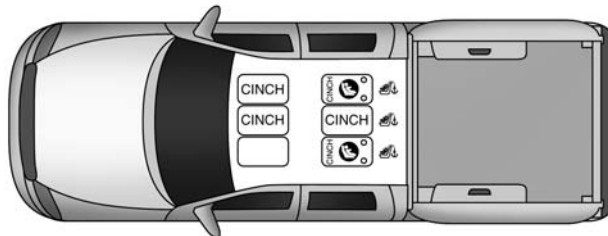

0226082992

Crew Cab (2008–2011 Model Years)

- CINCH — Cinching Latch Plate
- Lower Anchorage Symbol (2 Anchorages Per Seating Position)
- Top Tether Anchorage Symbol

Locating The LATCH Lower Anchorages In This Vehicle

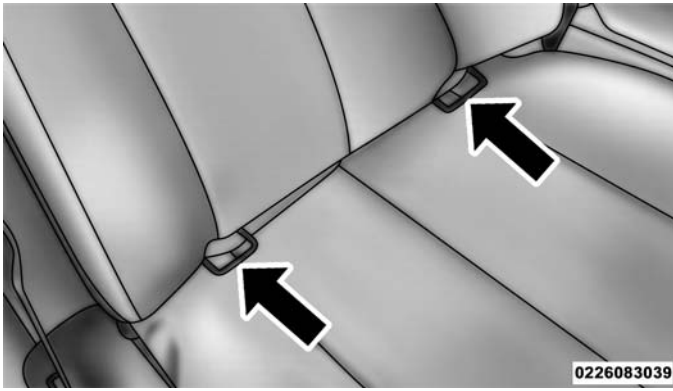

Front Passenger Seat, Club Cab (2005-2007 Model Years)

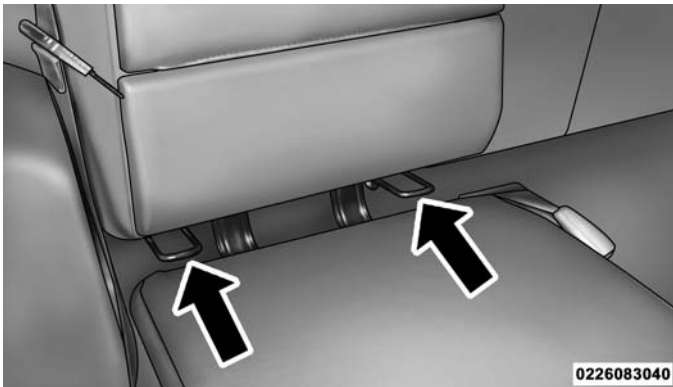

Rear Passenger Side Seat, Club Cab/Extended Cab (2005-2011 Model Years)

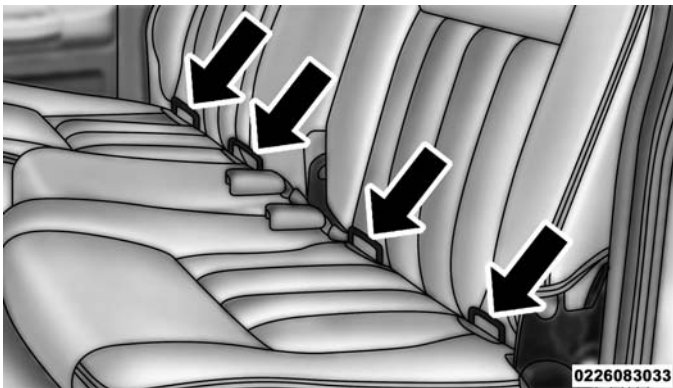

Rear Seat Quad Cab/Crew Cab (2005-2011 Model Years)

Locating The Tether Anchorages In This Vehicle



Club Cab/Extended Cab Models (2005-2011 Model Years)

A tether strap routing loop is located behind each of the rear outboard seating positions. The tether anchor itself is located in the center of vehicle, in between the two seating positions. This anchorage is shared by the outboard seating positions and two child restraints may be connected to this anchorage.

The front outboard passenger seating position is also equipped with a child tether anchorage, located at the base of the front seat back.

When there is a rear seat delete option, the tether anchorage located on the cab back panel is designed to be used for the front seat center seating position.

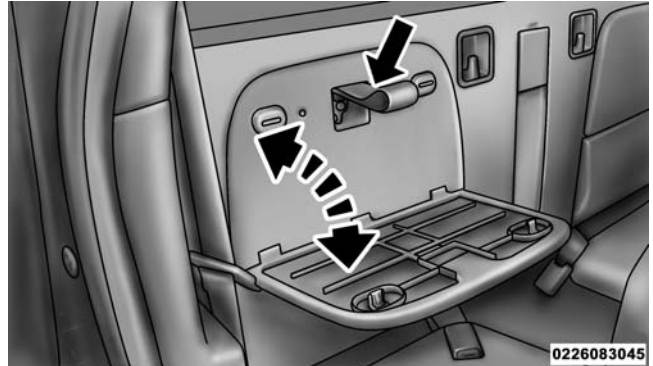

Rear Seat Tether Strap Routing Loop, Club Cab/Extended Cab (2005-2011 Model Years)

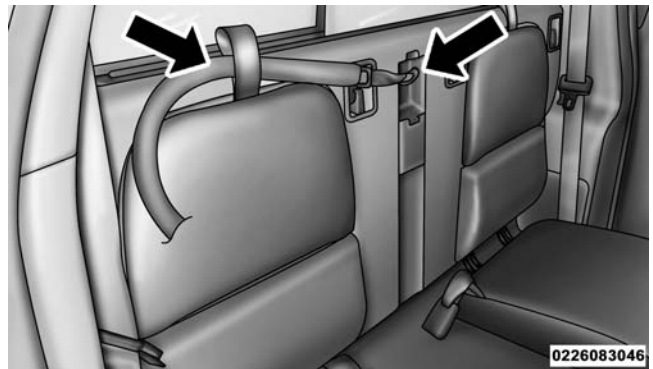

Rear Anchorage Location – Shared by Both Rear Seats, Club Cab/Extended Cab (2005-2011 Model Years)

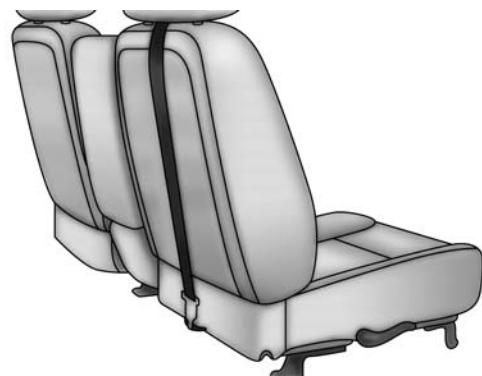

Front Passenger Seat – Club Cab/Extended Cab (2005-2011 Model Years)

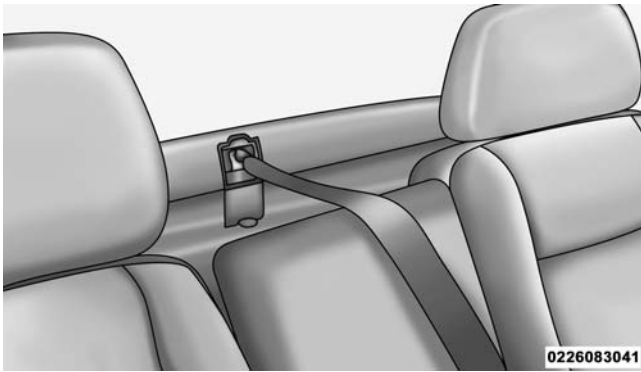

**Front Center Seat – Club Cab/Extended Cab
(2005-2011 Model Years) – Rear Seat Delete Option Only**

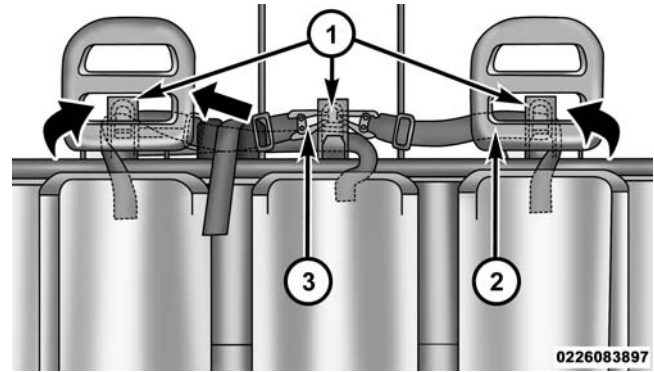

**Quad Cab/Crew Cab Tether Anchorages
(2005-2011 Model Years)**

Quad Cab/Crew Cab Models (2005-2011 Model Years)

There is a tether anchorage located behind each of the rear seating positions (rear left, rear center, and rear right).

1. Anchor Strap Metal Ring(s)
2. Tether Strap
3. Tether Strap Hook

Frequently Asked Questions About LATCH		
What is the weight limit (child’s weight + weight of the child restraint) for using the LATCH anchorage system to attach the child restraint?	65 lbs (29.5 kg)	Use the LATCH anchorage system until the combined weight of the child and the child restraint is 65 lbs (29.5 kg). Use the seat belt and tether anchor instead of the LATCH system once the combined weight is more than 65 lbs (29.5 kg).
Can the LATCH anchorages and the seat belt be used together to attach a rear-facing or forward-facing child restraint?	No	Do not use the seat belt when you use the LATCH anchorage system to attach a rear-facing or forward-facing child restraint.
Can two child restraints be attached using a common lower LATCH anchorage?	No	Never “share” a LATCH anchorage with two or more child restraints. If the center position does not have dedicated LATCH lower anchorages, use the seat belt to install a child seat in the center position next to a child seat using the LATCH anchorages in an outboard position.
Can the head restraints be removed?	No	
Quad Cab, 2005–2007 Model Years Crew Cab, 2008–2011 Model Years		
Can a child seat be installed in the center position using the inner LATCH lower anchorages?	Yes	You can install child restraints with flexible lower anchors in the center position.
2005–2006 Model Years		
Can the rear-facing child restraint touch the back of the front passenger seat?	No	Contact between the front passenger seat and a child restraint can affect the passenger airbag suppression system. See the vehicle owner’s manual for more information about the occupant classification system in your vehicle.
2007–2011 Model Years		
Can the rear-facing child restraint touch the back of the front passenger seat?	Yes	The child seat may touch the back of the front passenger seat if the child restraint manufacturer also allows contact. See your child restraint owner’s manual for more information.

Center Seat LATCH**Quad Cab/Crew Cab (2005-2011 Model Years)**

Do not install child restraints with rigid lower attachments in the center seating position. Only install this type of child restraint in the outboard seating positions. Child restraints with flexible, webbing mounted lower attachments can be installed in any rear seating position.

WARNING!

Never use the same lower anchorage to attach more than one child restraint. If you are installing LATCH-compatible child restraints next to each other, you must use the seat belt for the center position. You can then use either the LATCH anchors or the vehicle's seat belt for installing child seats in the outboard positions. Please refer to "Installing Child Restraints Using the LATCH Lower Anchorages" in the section "Installing Child Restraints" for typical installation instructions.

Directions For Attaching The Tether Anchorage**Front Passenger Seat, Club Cab/Extended Cab (2005-2011 Model Years)**

1. Place the child restraint on the front passenger seat.
2. Raise the head restraint, and where possible, route the tether strap under the head restraint and between the two posts. If not possible, lower the head restraint and pass the tether strap around the outboard side of the head restraint.
3. Attach the tether strap hook of the child restraint to the top tether anchorage as shown in the diagram.
4. Remove slack in the tether strap according to the child restraint manufacturer's instructions.

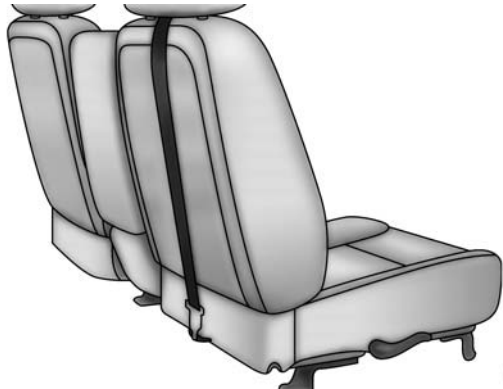

Front Passenger Seat Tether Anchorage, Club Cab/Extended Cab (2005-2011 Model Years)

Front Center Seat, Club Cab/Extended Cab, Rear Seat Delete Option (2005-2011 Model Years)

1. Place the child restraint on the front passenger seat.
2. Route the tether strap over the top of the vehicle seat and back to the tether anchorage on the back of the cab.
3. Attach the tether strap hook of the child restraint to the top tether anchorage as shown in the diagram.
4. Remove slack in the tether strap according to the child restraint manufacturer's instructions.

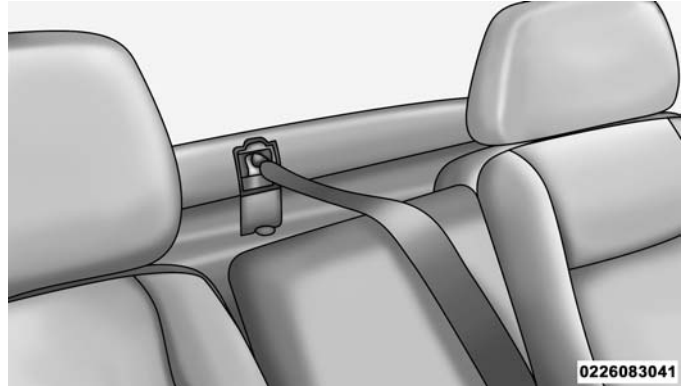

Front Center Seat Tether Anchorage, Club Cab/Extended Cab, Rear Seat Delete Option (2005-2011 Model Years)

WARNING!

Never place a rear-facing child restraint in front of an air bag. A deploying passenger Front Air Bag can cause death or serious injury to a child 12 years or younger, including a child in a rear-facing child restraint.

Rear Passenger Seat, Club Cab/Extended Cab (2005-2011 Model Years)

1. Route the child restraint tether strap through the anchor strap loop, located directly behind the child restraint. The anchor strap loops are located behind the flip-down door on the cab back panel (padded bolster).
2. Route the tether strap across to the center tether anchorage. The center tether is located behind the flip-down cover in the center of the vehicle, between the two seating positions.
3. Remove the slack in the tether strap so that the anchor strap is pulled tight.

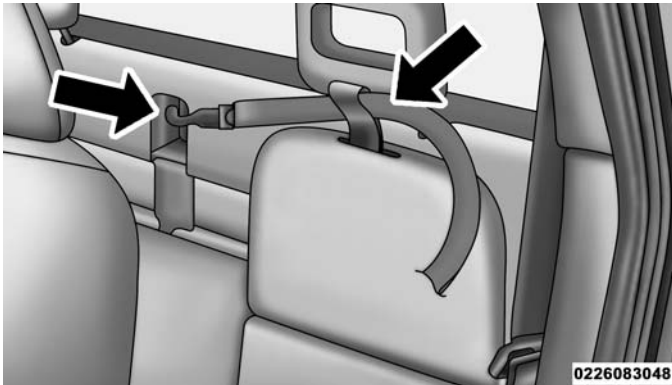
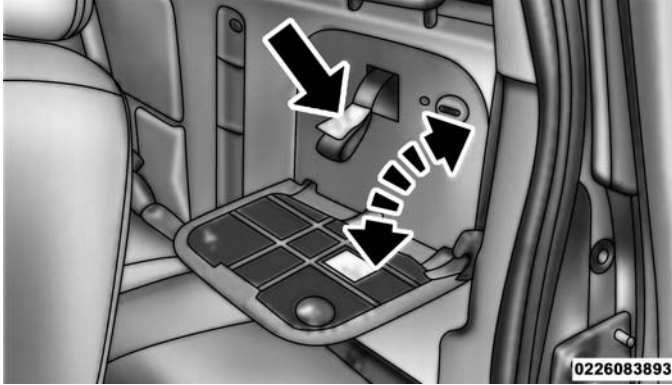

Rear Passenger Seat, Quad Cab/Crew Cab (2005-2011 Model Years)

1. Route the child restraint tether strap under the head restraint for the outboard seating positions, and then through the anchor strap loop, located directly behind the child restraint.
2. Route the tether strap across to the nearest installed anchor strap loop, and attach the tether strap hook to the anchor strap metal ring.
3. Remove the slack in the tether strap so that both anchor straps are pulled tight.

NOTE: Two Anchors must be used for any of the three seating positions.

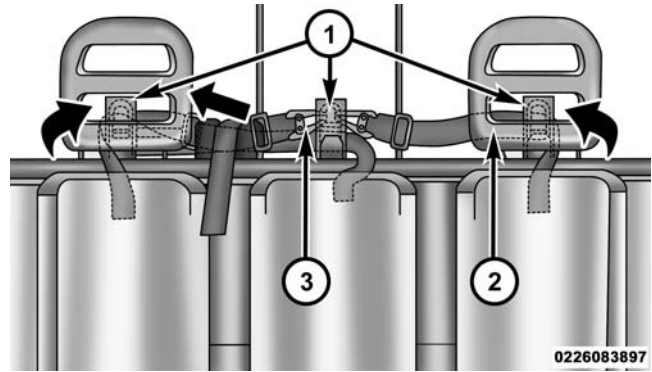

Rear Seat Tether Anchorages, Quad Cab/Crew Cab (2005-2011 Model Years)

1. Anchor Strap Metal Ring(s)
2. Tether Strap
3. Tether Strap Hooks

Multiple Child Restraint Installation Sequence – Quad Cab/Crew Cab Rear Seat

1. Thread the child restraint tether strap hook through the anchor strap loop, located directly behind the child restraint.
2. After following step 1 for either of the two outer seats, route the tether strap hook to the metal ring on the anchor strap behind the center seat and attach the hook to the metal ring.
3. After following step 1 for the center child restraint, route the tether strap hook to the metal ring on the anchor strap loop, located behind the passenger’s seat.
4. Attach the tether strap hook to the anchor strap metal ring.
5. Remove the slack in the tether straps so that the anchor straps are all pulled tight.

NOTE: Two Anchors must be used for each of the three seating positions as shown in the diagram.

Seat Belt Systems In Your Vehicle

Lap/Shoulder Belt Systems For Installing Child Restraints In This Vehicle

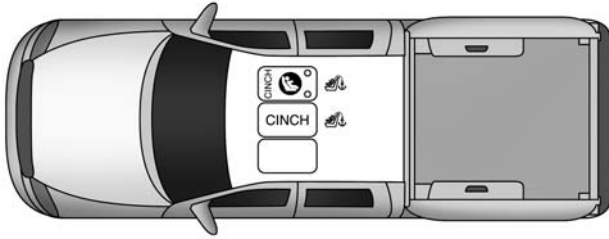

0226082986

No Rear Seat Club Cab (2005–2007 Model Years)

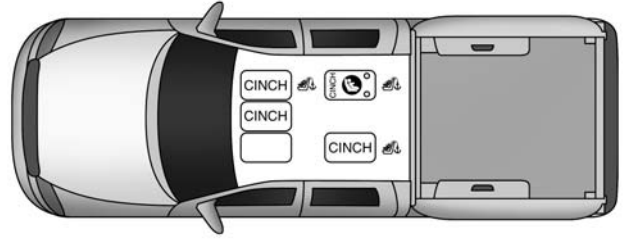

0226082993

Rear Jump Seat Extended Cab (2008–2011 Model Years)

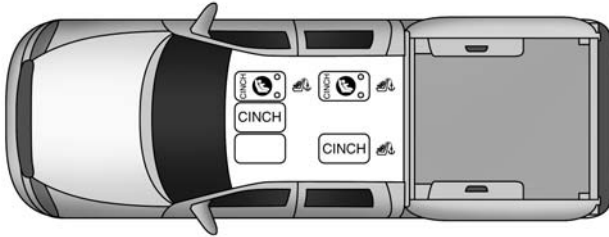

0226083891

Rear Jump Seat Club Cab (2005–2007 Model Years)

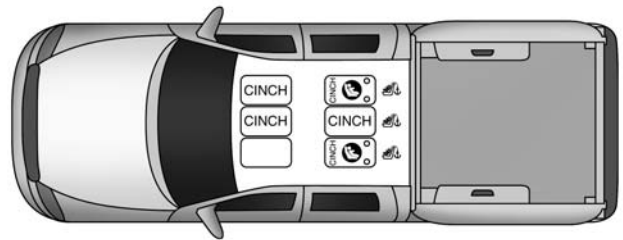

0226082992

Crew Cab (2008–2011 Model Years)

- CINCH — Cinching Latch Plate
- Lower Anchorage Symbol (2 Anchorages Per Seating Position)
- Top Tether Anchorage Symbol

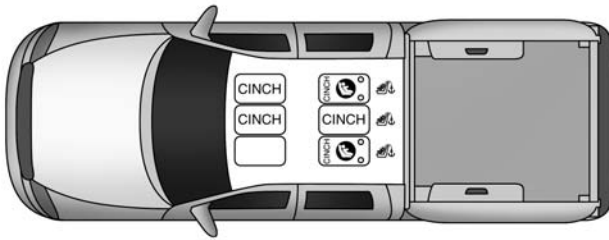

0226082990

Quad Cab (2005–2007 Model Years)

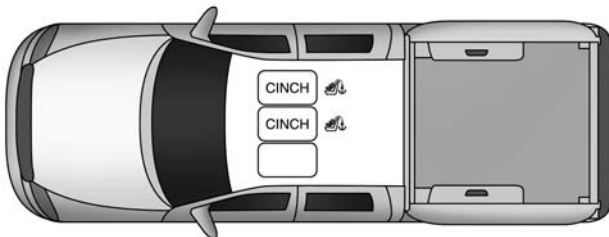

0226082991

No Rear Seat Extended Cab (2008–2011 Model Years)

Frequently Asked Questions About Seat Belts And Car Seats

What is the weight limit (child’s weight + weight of the child restraint) for using the Tether Anchor with the seat belt to attach a forward facing child restraint?	Weight Limit of the Child Restraint	Always use the tether anchor when using the seat belt to install a forward facing child restraint, up to the recommended weight limit of the child restraint.
Can the head restraints be removed?	No	
Can the buckle stalk be twisted to tighten the seat belt against the belt path of the child restraint?	Yes	In positions with cinching latch plates (CINCH), the buckle stalk may be twisted up to 3 full turns. Do not twist the buckle stalk in a seating position with an ALR retractor.
2005–2006 Model Years		
Can the rear-facing child restraint touch the back of the front passenger seat?	No	Contact between the front passenger seat and a child restraint can affect the passenger airbag suppression system. See the vehicle owner’s manual for more information about the occupant classification system in your vehicle.
2007–2011 Model Years		
Can the rear-facing child restraint touch the back of the front passenger seat?	Yes	Contact between the front passenger seat and the child restraint is allowed, if the child restraint manufacturer also allows contact.

DODGE RAM 1500, 2001–2009

LATCH And Tethers In Your Vehicle

LATCH Positions For Installing Child Restraints In This Vehicle:

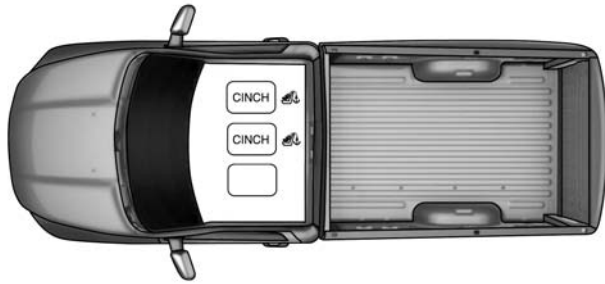

0226082955

Regular Cab (2001–2002 Model Years)

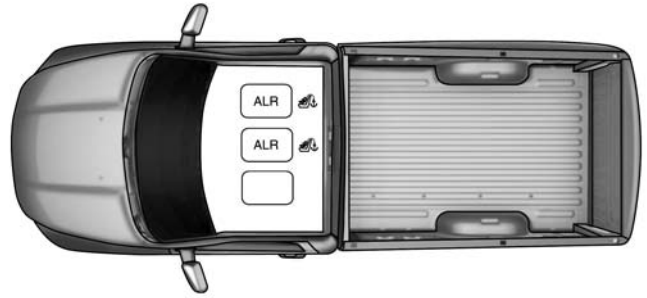

0226082961

Regular Cab (2008–2009 Model Years)

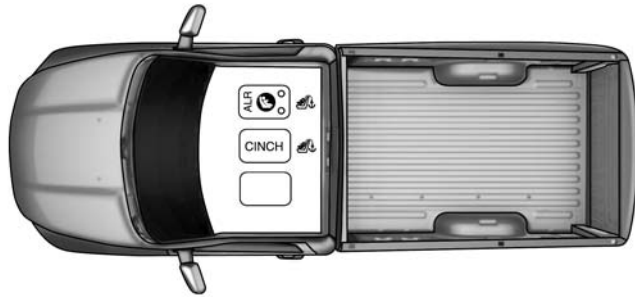

0226082957

Regular Cab (2003–2005 Model Years)

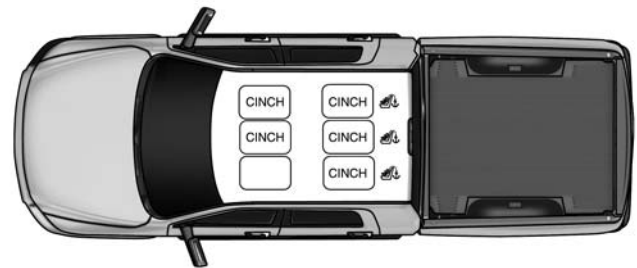

0226082954

Quad Cab (2001–2002 Model Years)

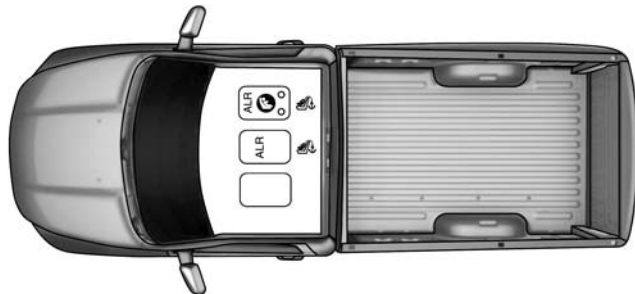

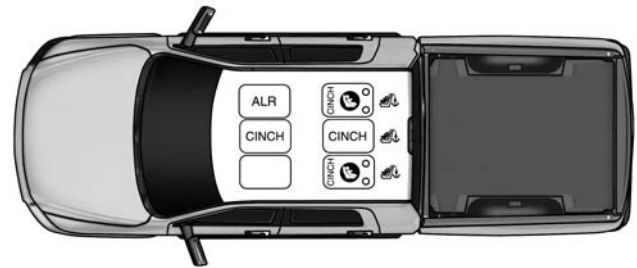

0226082958

Regular Cab (2006–2007 Model Years)



0226082956

Quad Cab (2003–2005 Model Years)

- ALR — Switchable Automatic Locking Retractor
- CINCH — Cinching Latch Plate
-  Lower Anchorage Symbol (2 Anchorages Per Seating Position)
-  Top Tether Anchorage Symbol

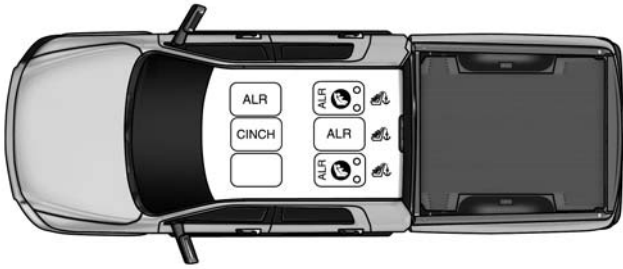

0226082960

Quad Cab (2006–2008 Model Years)

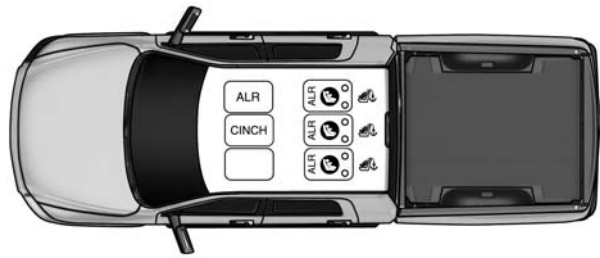

0226082959

Mega Cab (2006–2008 Model Years)

- ALR — Switchable Automatic Locking Retractor
- CINCH — Cinching Latch Plate
- Lower Anchorage Symbol (2 Anchorages Per Seating Position)
- Top Tether Anchorage Symbol

Locating The LATCH Lower Anchorages In This Vehicle

NOTE: 2001-2002 Dodge Ram 1500 did not have lower anchorages.

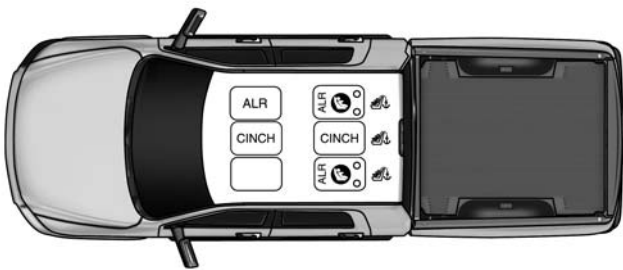

0226082962

Quad Cab/Crew Cab, Full Bench (2009 Model Year)

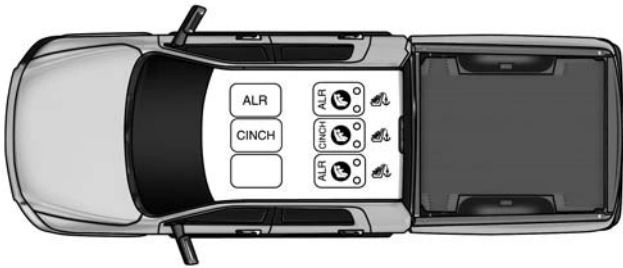

0226082963

Quad Cab/Crew Cab, Split Bench (2009 Model Year)

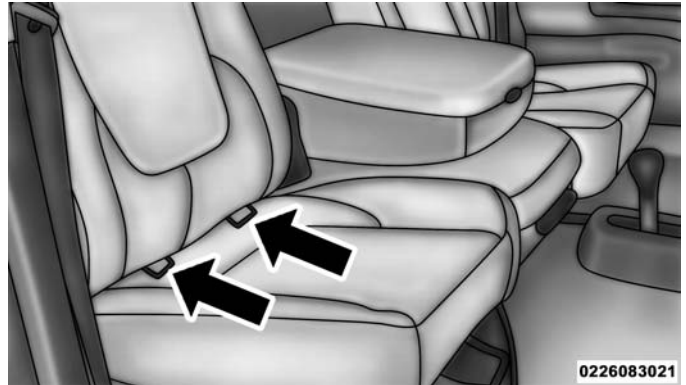

0226083021

Regular Cab Front Passenger Seat Anchorages (2003-2007 Model Years)

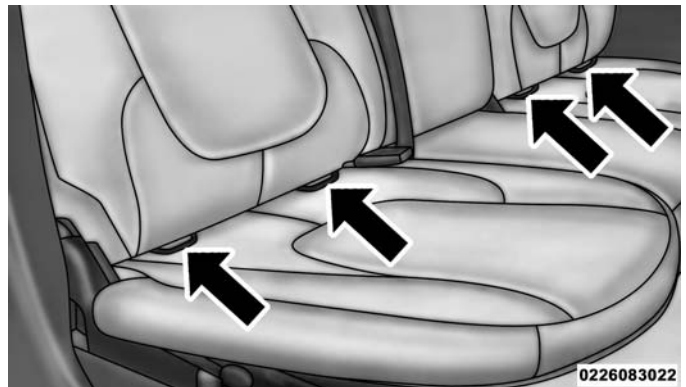

0226083022

Quad Cab/Crew Cab Full Bench Rear Seat (2003-2009 Model Years)

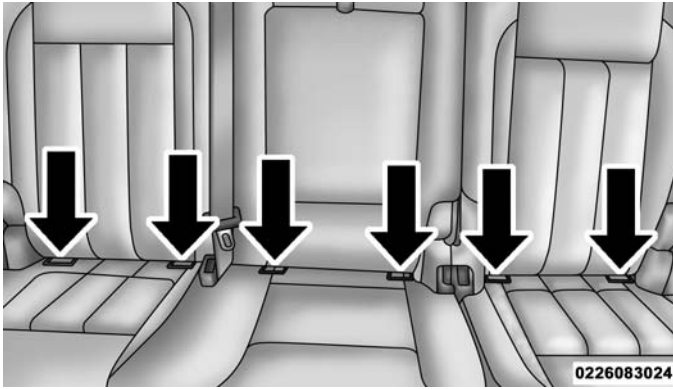

Mega Cab Rear Seats (2006 - 2008 Model Years) and Quad Cab/Crew Cab Split Bench Seats (2009 Model Year)

Locating The Tether Anchorages In This Vehicle



2001 Model Year

Regular Cab models have tether strap anchorages behind the front center and right seats

Quad Cab models have tether strap anchorages located behind each of the rear seats.

The Quad Cab model without a rear seat (rear seat delete option) has an anchorage for the center seat on the rear panel of the cab behind the center front seat, and an anchorage for the right passenger seat on the inboard seat adjuster.

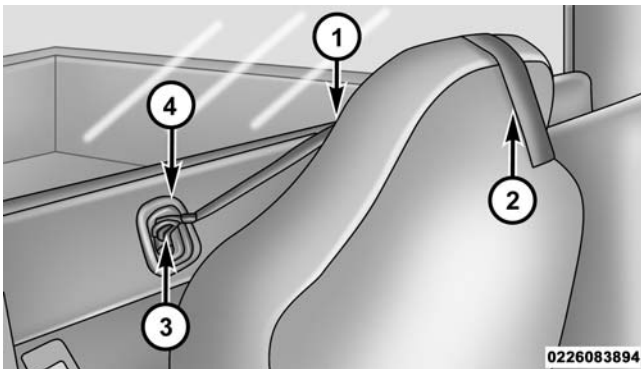

Regular Cab, Center And Right Front Seat (2001 Model Year)

1. Tether Strap
2. Tether Strap To Child Restraint
3. Tether Anchorage
4. Tether Strap Hook

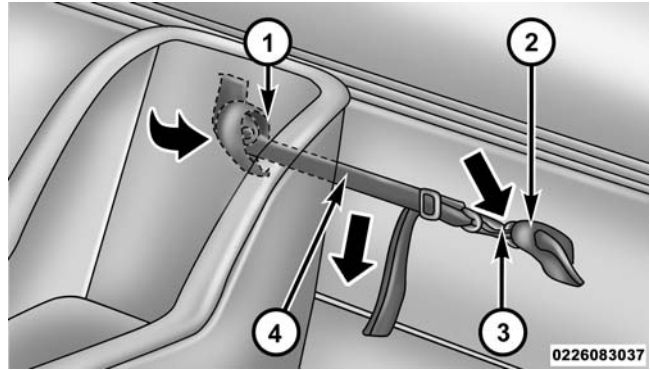

Quad Cab Rear Seats (2001 Model Year)

1. Anchor Strap Loop
2. Anchor Strap Metal Ring
3. Tether Strap Hook
4. Tether Strap

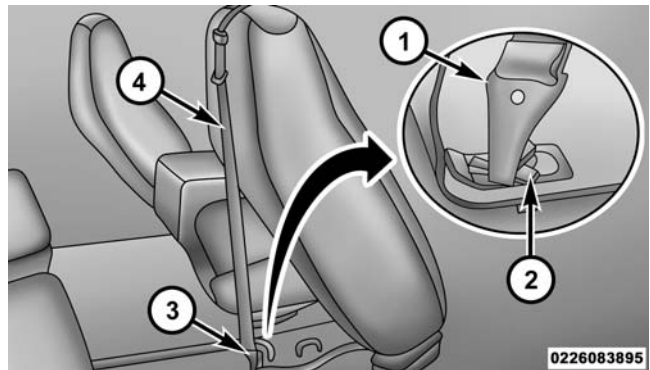

Quad Cab Front Passenger, With Rear Seat Delete Option (2001 Model Year)

1. Tether Strap Hook
2. Tether Anchorage
3. Tether Strap Hook
4. Tether Strap

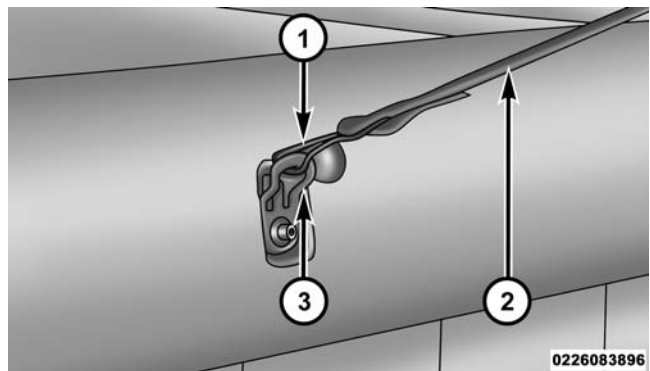

Quad Cab Front Center, With Rear Seat Delete Option (2001 Model Year)

1. Tether Strap Hook
2. Tether Strap
3. Tether Anchorage

2002–2009 Model Years

Regular Cab models have tether strap anchorages behind the front center and right seats. Quad Cab, Mega Cab and Crew Cab models have tether strap anchorages located behind each of the rear seats.

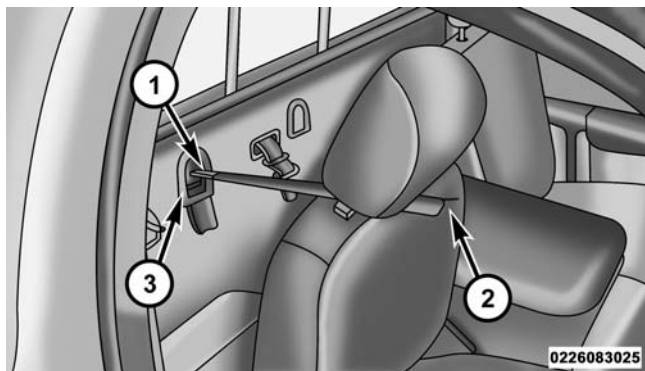

Regular Cab Tether Anchorages (2002-2009 Model Years)

1. Tether Strap Hook
2. Tether Strap To Child Restraint
3. Tether Anchorage

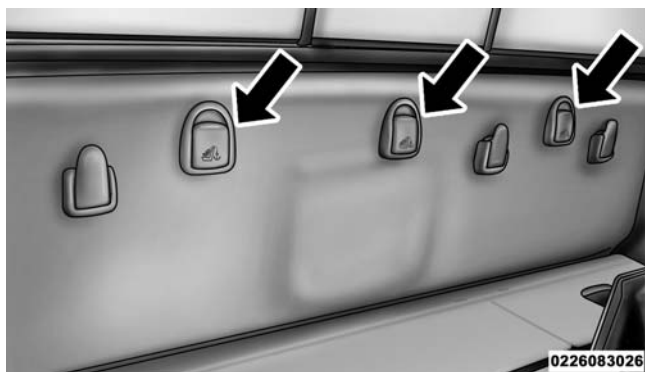

Mega Cab Tether Anchorages (2006-2008 Model Years)



Quad Cab/Crew Cab Tether Anchorages (2002-2009 Model Years)



Quad Cab/Crew Cab Tether Anchorages (2002-2009 Model Years)

Frequently Asked Questions About LATCH		
Can the LATCH anchorages and the seat belt be used together to attach a rear-facing or forward-facing child restraint?	No	Do not use the seat belt when you use the LATCH anchorage system to attach a rear-facing or forward-facing child restraint.
Can two child restraints be attached using a common lower LATCH anchorage?	No	Never “share” a LATCH anchorage with two or more child restraints. If the center position does not have dedicated LATCH lower anchorages, use the seat belt to install a child seat in the center position next to a child seat using the LATCH anchorages in an outboard position.
Can the rear-facing child restraint touch the back of the front passenger seat?	Yes	The child seat may touch the back of the front passenger seat if the child restraint manufacturer also allows contact. See your child restraint owner’s manual for more information.
Can the head restraints be removed?	No	
Quad Cab, 2002–2008 Model Years Quad Cab/Crew Cab with Full Bench Seat, 2009 Model Year		
Can a child seat be installed in the center position using the inner LATCH lower anchorages?	No	Use the seat belt and tether anchor to install a child seat in the center seating position.

Frequently Asked Questions About LATCH

2002–2008 Model Years

What is the weight limit (child's weight + weight of the child restraint) for using the LATCH anchorage system to attach the child restraint?	65 lbs (29.5 kg)	Use the LATCH anchorage system until the combined weight of the child and the child restraint is 65 lbs (29.5 kg). Use the seat belt alone instead of the LATCH anchorage system once the combined weight is more than 65 lbs (29.5 kg).
2009 Model Year		
What is the weight limit (child's weight + weight of the child restraint) for using the LATCH anchorage system to attach the child restraint?	65 lbs (29.5 kg)	Use the LATCH anchorage system until the combined weight of the child and the child restraint is 65 lbs (29.5 kg). Use the seat belt and tether anchor instead of the LATCH system once the combined weight is more than 65 lbs (29.5 kg).

Center Seat LATCH

Quad Cab (2003–2008 Model Years), Quad Cab/Crew Cab Full Bench Seat (2009 Model Year)

WARNING!

- Do not install a child restraint in the center position using the LATCH system. This position is not approved for installing child seats using the LATCH attachments. You must use the seat belt and tether anchor to install a child seat in the center seating position.
- Never use the same lower anchorage to attach more than one child restraint. Please refer to "Installing Child Restraints Using the LATCH Lower Anchorages" in the section "Installing Child Restraints" for typical installation instructions.

Mega Cab (2006–2008 Model Years), Quad Cab/Crew Cab Split Bench Seat (2009 Model Years)

If a child restraint installed in the center position blocks the seat belt webbing or buckle for the outboard position, do not use that outboard position. If a child seat in the center position blocks the outboard LATCH anchors or seat belt, do not install a child seat in that outboard position.

WARNING!

Never use the same lower anchorage to attach more than one child restraint. Please refer to "Installing Child Restraints Using the LATCH Lower Anchorages" in the section "Installing Child Restraints" for typical installation instructions.

Directions For Attaching The Tether Anchorage

2001 Model Year

Regular Cab, Center and Right Front Seats (2001 Model Year)

1. Place the child restraint on the front passenger or center seat.
2. Route the tether strap over the top of the vehicle seat and back to the tether anchorage on the back of the cab.
3. Lift the cover (if equipped with one) and attach the tether strap hook of the child restraint to the top tether anchorage as shown in the diagram.
4. Remove slack in the tether strap according to the child restraint manufacturer's instructions.

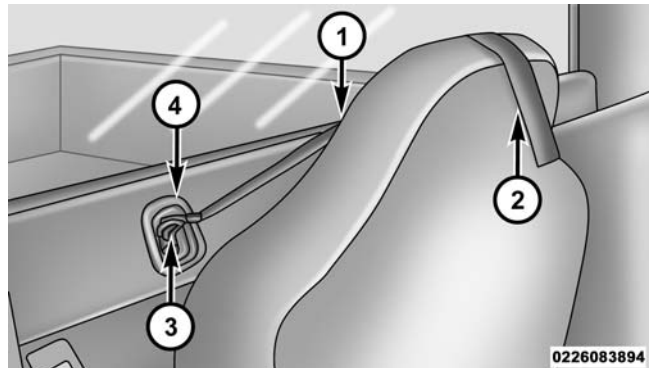

Regular Cab, Center And Right Front Seat
(2001 Model Year)

1. Tether Strap
2. Tether Strap To Child Restraint
3. Tether Anchorage
4. Tether Strap Hook

Quad Cab, Front Passenger Seat, Rear Seat Delete Option (2001 Model Year)

1. Place the child restraint on the front passenger seat.
2. Route the tether strap over the top of the vehicle seat and down to the tether anchorage located at the bottom rear of the seat, on the inboard seat adjuster.
3. Attach the tether strap hook of the child restraint to the top tether anchorage as shown in the diagram.
4. Remove slack in the tether strap according to the child restraint manufacturer’s instructions.

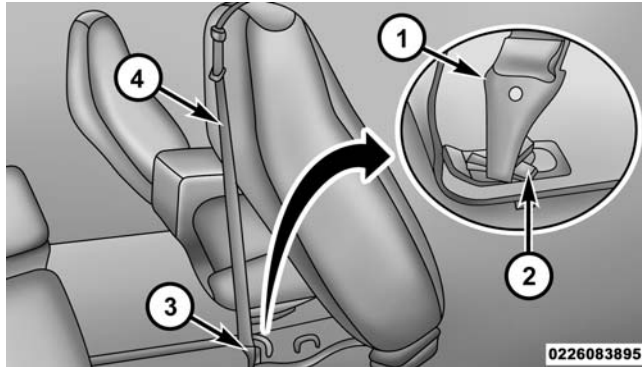

Quad Cab Front Passenger, With Rear Seat Delete Option (2001 Model Year)

1. Tether Strap Hook
2. Tether Anchorage
3. Tether Strap Hook
4. Tether Strap

Quad Cab, Center Front Seat, Rear Seat Delete Option (2001 Model Year)

1. Place the child restraint on the front center seat.
2. Route the tether strap over the top of the vehicle seat and back to the tether anchorage on the back of the cab.
3. Lift the cover (if equipped with one) and attach the tether strap hook of the child restraint to the top tether anchorage as shown in the diagram.
4. Remove slack in the tether strap according to the child restraint manufacturer’s instructions.

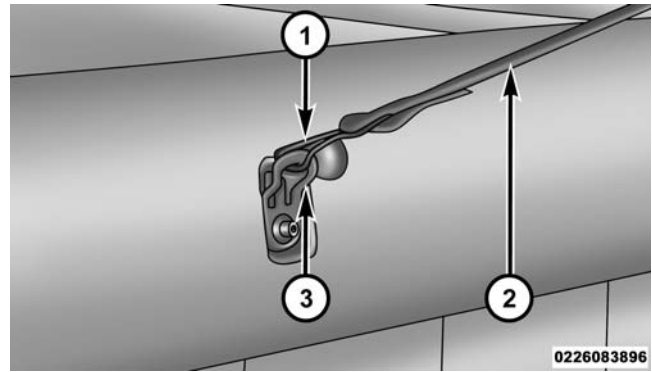

Quad Cab Front Center, With Rear Seat Delete Option (2001 Model Year)

1. Tether Strap Hook
2. Tether Strap
3. Tether Anchorage

WARNING!
Never place a rear-facing child restraint in front of an air bag. A deploying passenger Front Air Bag can cause death or serious injury to a child 12 years or younger, including a child in a rear-facing child restraint.

Regular Cab/Mega Cab (2002-2009 Model Years)

In the regular cab truck, the top tether anchorages are located behind the center and right passenger seats. In the mega cab truck, the top tether anchorages are located behind each rear seating position. There is a plastic cover over each anchorage. To attach the tether strap of the child restraint:

1. Place the child restraint on the seat and adjust the tether strap so that it will reach over the seat back, under the head restraint and to the tether anchorage directly behind the seat.
2. Route the tether strap to provide the most direct path between the anchorage and the child seat. The tether strap should go between the head restraint posts underneath the head restraint. You may need to adjust the head restraint to the upward position to pass the tether strap underneath the head restraint and between its posts.
3. Lift the cover (if so equipped), and attach the tether strap hook to the square opening in the sheet metal.

4. Tighten the tether strap according to the child seat manufacturer's instructions.

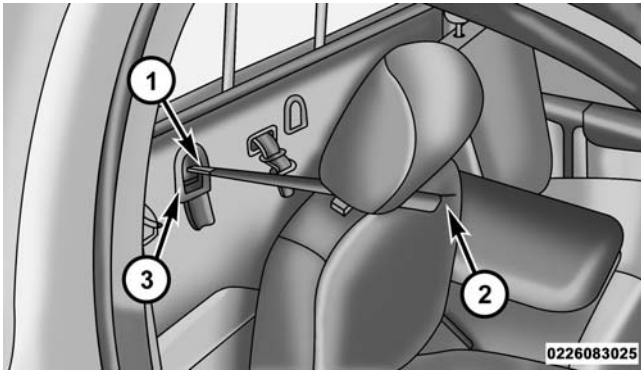

Regular Cab Tether Anchorages (2002-2009 Model Years)

1. Tether Strap Hook
2. Tether Strap To Child Restraint
3. Tether Anchorage

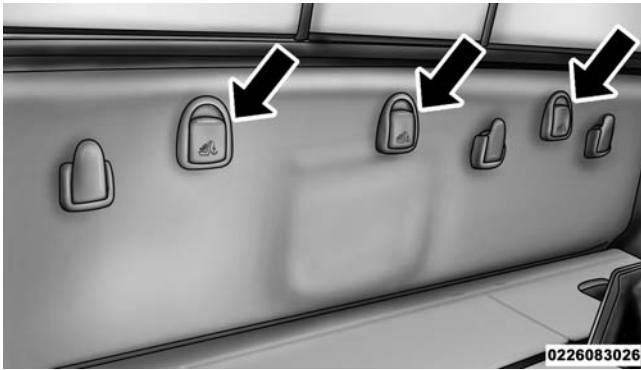

Mega Cab Tether Anchorages (2006-2008 Model Years)

WARNING!

Never place a rear-facing child restraint in front of an air bag. A deploying passenger Front Air Bag can cause death or serious injury to a child 12 years or younger, including a child in a rear-facing child restraint.

Quad Cab (2001-2008 Model Years)

The top tether anchorages in this vehicle are tether strap loops located between the rear glass and the back of the rear seat. There is a tether strap loop located behind each seating position. Follow the steps below to attach the tether strap of the child restraint.

Right or Left Outboard Seats:

1. Raise the head restraint and reach between the rear seat and rear glass to access the tether strap loop.
2. Place a child restraint on the seat and adjust the tether strap so that it will reach over the seat back, under the head restraint, through the tether strap loop behind the seat and over to the anchorage behind the center seat.
3. Pass the tether strap hook under the head restraint behind the child seat, through the tether strap loop behind the seat and over to the center tether anchorage.

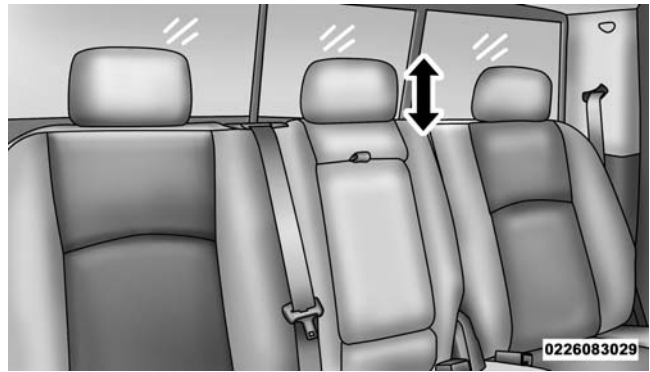

4. Attach the tether strap hook to the center anchor strap metal ring (see diagram).

5. Tighten the tether strap according to the child seat manufacturer's instructions.

NOTE: If there are child seats in both of the outboard (left and right) seating positions, the tether strap hooks of both child seats should be connected to the center anchor strap metal ring. This is the correct way to tether two outboard child seats.

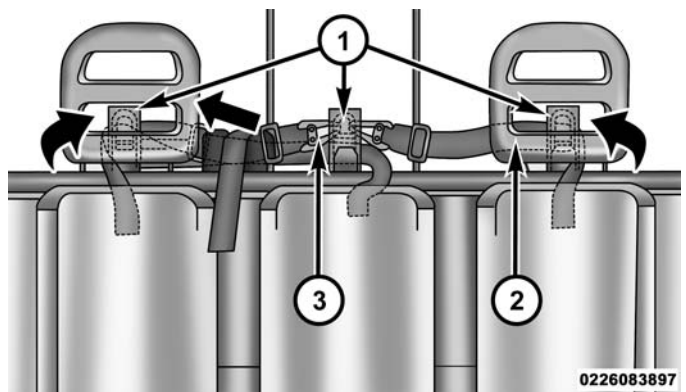

Multiple Child Restraints, Quad Cab (2001-2008 Model Years)

1. Anchor Strap Metal Ring(s)
2. Tether Strap
3. Tether Strap Hook

Center Seat:

1. Raise the head restraint and reach between the rear seat and rear glass to access the tether strap loop.
2. Place a child restraint on the seat and adjust the tether strap so that it will reach over the seat back, under the head restraint, through the tether strap loop behind the seat and over to the anchorage behind the passenger side outboard seat.
3. Pass the tether strap hook under the head restraint behind the child seat, through the tether strap loop behind the seat and over to the right outboard tether anchorage.
4. Attach the tether strap hook to the anchor strap metal ring behind the right outboard seating position.
5. Tighten the tether strap according to the child seat manufacturer's instructions.

Installing Three Child Restraints:

1. Place a child restraint on each outboard rear seat. Route the tether straps following the directions for right and left seating positions, above.
2. Attach both tether strap hooks to the center anchor strap metal ring, but do not tighten the straps yet.
3. Place a child restraint on the center rear seat. Route the tether strap following the directions for the center seating position, above.
4. Attach the tether strap hook to the passenger side outboard anchor strap metal ring.
5. Tighten the tether straps according to the child seat manufacturer's instructions, tightening the right and left tether straps before the center tether strap.

WARNING!

- An incorrectly anchored tether strap could lead to increased head motion and possible injury to the child. Use only the anchorage position directly behind the child seat to secure a child restraint top tether strap.
- If your vehicle is equipped with a split rear seat, make sure the tether strap does not slip into the opening between the seatbacks as you remove slack in the strap.

Quad Cab/Crew Cab (2009 Model Year)

The top tether anchorages in this vehicle are tether strap loops located between the rear glass and the back of the rear seat. There is a tether strap loop located behind each seating position. Follow the steps below to attach the tether strap of the child restraint.

1. Raise the head restraint and reach between the rear seat and rear glass to access the tether strap loop.



Head Restraint In Raised Position

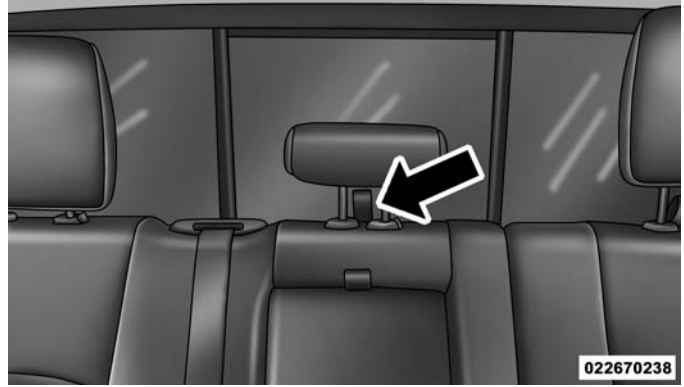

Tether Strap Loop With Center Head Restraint In Raised Position

2. Place a child restraint on the seat and adjust the tether strap so that it will reach over the seat back, under the head restraint, through the tether strap loop behind the seat and over to the tether strap loop behind the center seat.
3. Pass the tether strap hook under the head restraint behind the child seat, through the tether strap loop behind the seat and over to the center tether strap loop.

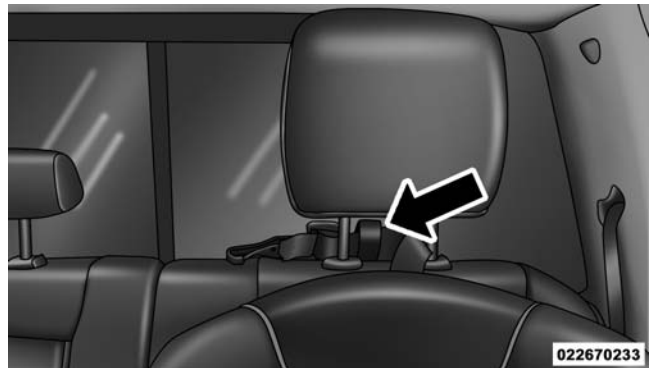

Tether Strap Through Outboard Tether Strap Loop

4. Attach the tether strap hook to the center tether strap loop (see diagram).
5. Tighten the tether strap according to the child seat manufacturer's instructions.

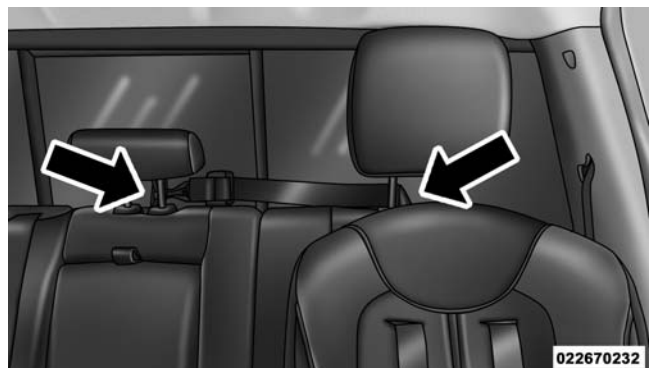

Tether Strap Through Outboard Tether Strap Loop And Attached To Center Tether Strap Loop

NOTE: If there are child seats in both of the outboard (left and right) seating positions, the tether strap hooks of both child seats should be connected to the center tether strap loop. This is the correct way to tether two outboard child seats.

Center Seat:

1. Raise the head restraint and reach between the rear seat and rear glass to access the tether strap loop.

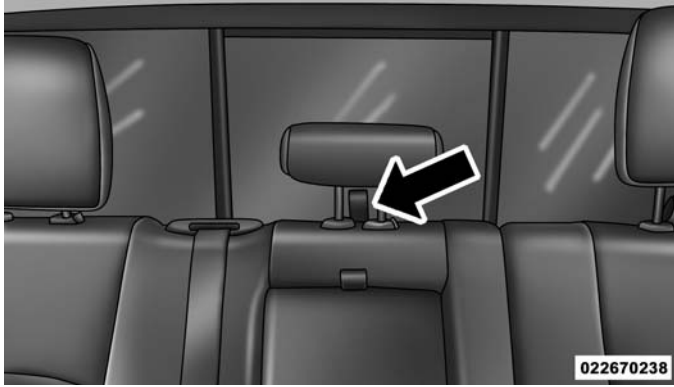

Tether Strap Loop With Head Restraint In Raised Position

2. Place a child restraint on the seat and adjust the tether strap so that it will reach over the seat back, under the head restraint, through the tether strap loop behind the seat and over to the tether strap loop behind either the right or left outboard seat.
3. Pass the tether strap hook under the head restraint behind the child seat, through the tether strap loop behind the seat and over to the right or left outboard tether strap loop.

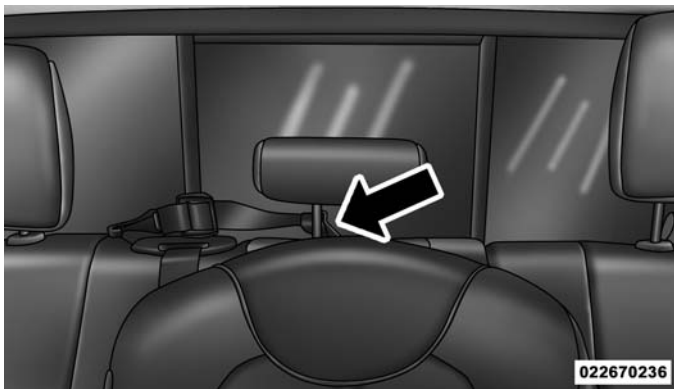

Tether Strap Through Center Tether Strap Loop

4. Attach the tether strap hook to the outboard tether strap loop (see diagram).
5. Tighten the tether strap according to the child seat manufacturer's instructions.

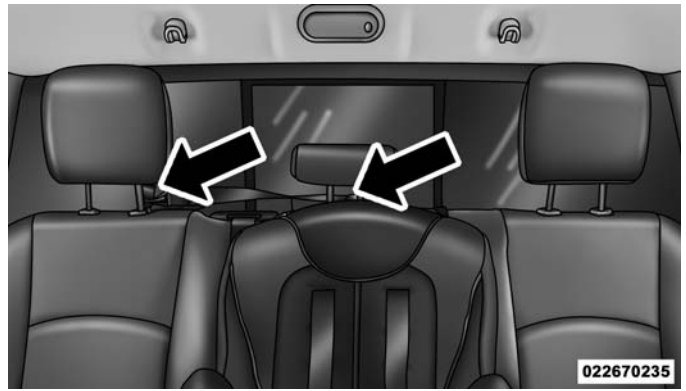

Tether Strap Through Center Tether Strap Loop And Attached To Outboard Tether Strap Loop

Installing Three Child Restraints:

1. Place a child restraint on each outboard rear seat. Route the tether straps following the directions for right and left seating positions, above.
2. Attach both tether strap hooks to the center tether strap loop, but do not tighten the straps yet.
3. Place a child restraint on the center rear seat. Route the tether strap following the directions for the center seating position, above.
4. Attach the tether strap hook to the outboard tether strap loop.
5. Tighten the tether straps according to the child seat manufacturer's instructions, tightening the right and left tether straps before the center tether strap.

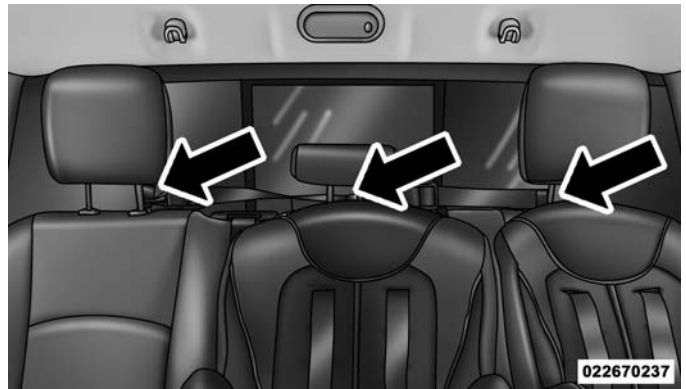

Left Outboard And Center Seating Position Shown

WARNING!

- An incorrectly anchored tether strap could lead to increased head motion and possible injury to the child. Use only the anchorage position directly behind the child seat to secure a child restraint top tether strap.
- If your vehicle is equipped with a split rear seat, make sure the tether strap does not slip into the opening between the seatbacks as you remove slack in the strap.

Seat Belt Systems In Your Vehicle

Lap/Shoulder Belt Systems For Installing Child Restraints In This Vehicle:

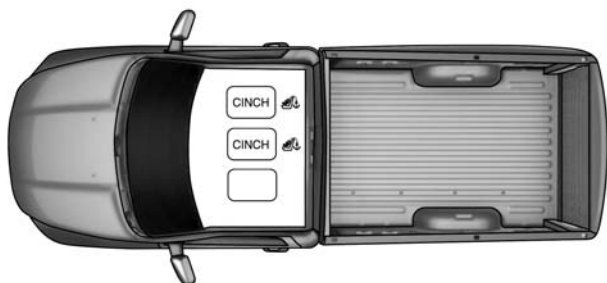

0226082955

Regular Cab (2001–2002 Model Years)

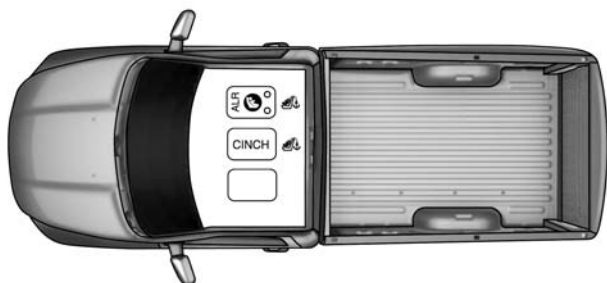

0226082957

Regular Cab (2003–2005 Model Years)

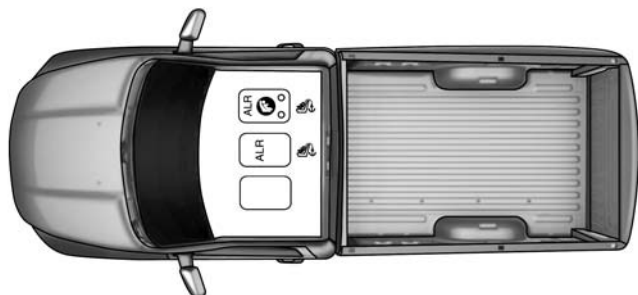

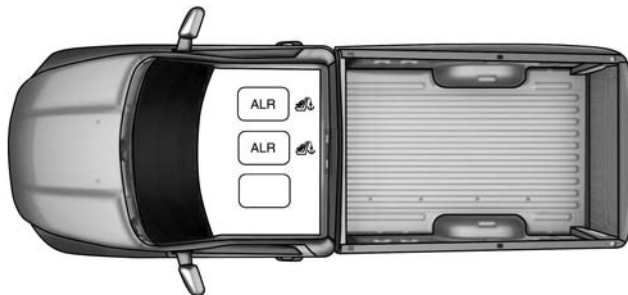

0226082958

Regular Cab (2006–2007 Model Years)



0226082961

Regular Cab (2008–2009 Model Years)

- ALR — Switchable Automatic Locking Retractor
- CINCH — Cinching Latch Plate
-  Lower Anchorage Symbol (2 Anchorages Per Seating Position)
-  Top Tether Anchorage Symbol

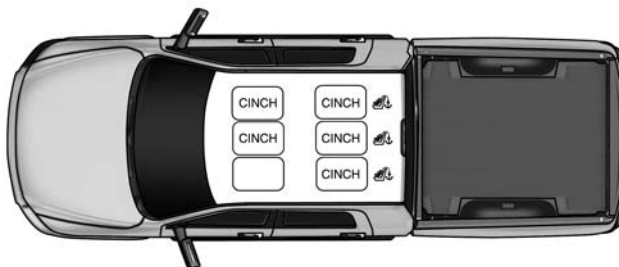

0226082954

Quad Cab (2001–2002 Model Years)

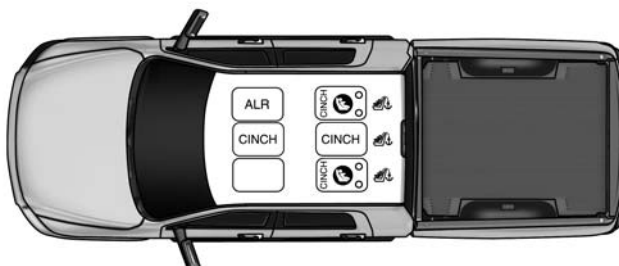

0226082956

Quad Cab (2003–2005 Model Years)



0226082960

Quad Cab (2006–2008 Model Years)



0226082959

Mega Cab (2006–2008 Model Years)

- ALR — Switchable Automatic Locking Retractor
- CINCH — Cinching Latch Plate
- Lower Anchorage Symbol (2 Anchorages Per Seating Position)
- Top Tether Anchorage Symbol

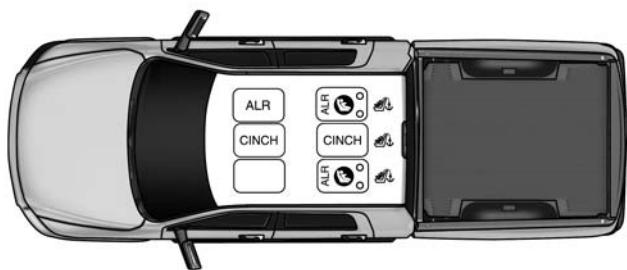

0226082962

Quad Cab/Crew Cab, Full Bench (2009 Model Year)

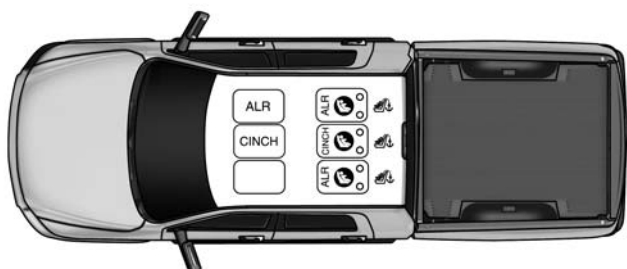

0226082963

Quad Cab/Crew Cab, Split Bench (2009 Model Year)

Frequently Asked Questions About Seat Belts And Car Seats

Can the rear-facing child restraint touch the back of the front passenger seat?	Yes	Contact between the front passenger seat and the child restraint is allowed, if the child restraint manufacturer also allows contact.
Can the head restraints be removed?	No	
Can the buckle stalk be twisted to tighten the seat belt against the belt path of the child restraint?	Yes	In positions with cinching latch plates (CINCH), the buckle stalk may be twisted up to 3 full turns. Do not twist the buckle stalk in a seating position with an ALR retractor.
2001–2008 Model Years		
What is the weight limit (child’s weight + weight of the child restraint) for using the Tether Anchor with the seat belt to attach a forward facing child restraint?	65 lbs (29.5 kg)	The Tether Anchor can be used with the seat belt until the combined weight of the child and the child restraint is 65 lbs (29.5 kg). Use the seat belt without the Tether Anchor once the combined weight is more than 65 lbs (29.5 kg).
2009 Model Year		
What is the weight limit (child’s weight + weight of the child restraint) for using the Tether Anchor with the seat belt to attach a forward facing child restraint?	Weight limit of the Child Restraint	Always use the tether anchor when using the seat belt to install a forward facing child restraint, up to the recommended weight limit of the child restraint.

WARNING!

Do not install a rear-facing car seat using a rear support leg in this vehicle. The floor of this vehicle is not designed to manage the crash forces of this type of car seat. In a crash, the support leg may not function as it was designed by the car seat manufacturer, and your child may be more severely injured as a result.



0226047161

DODGE RAM 2500/3500, 2001–2009

LATCH And Tethers In Your Vehicle

LATCH Positions For Installing Child Restraints In This Vehicle

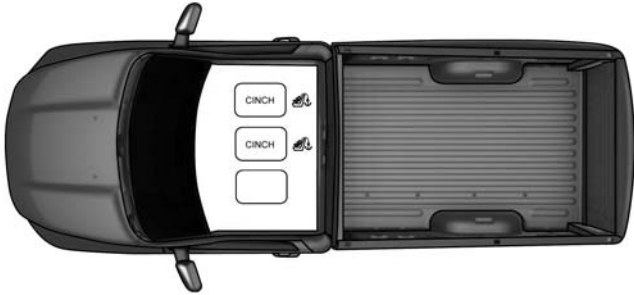

0226082965

Regular Cab (2001–2002 Model Years)

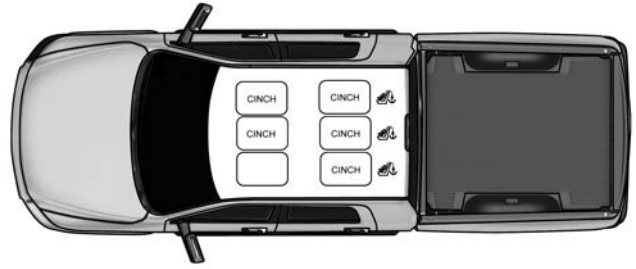

0226082964

Quad Cab (2001–2002 Model Years)

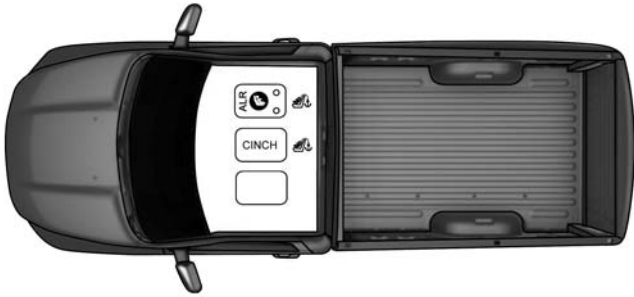

0226082967

Regular Cab (2003–2005 Model Years)

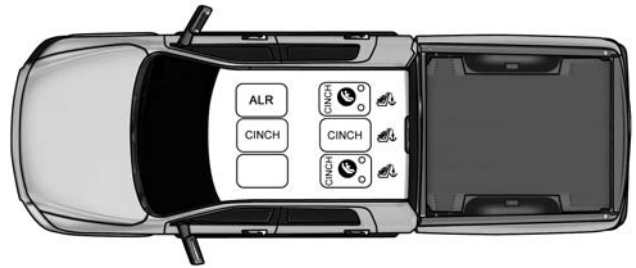

0226082966

Quad Cab (2003–2005 Model Years)

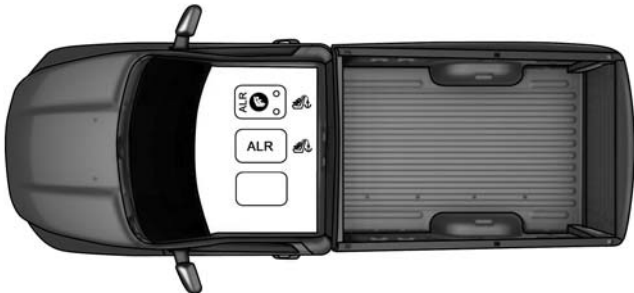

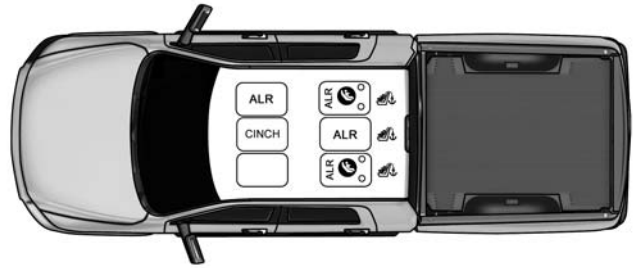

0226082968

Regular Cab (2006–2009 Model Years)



0226082971

Quad Cab (2006–2009 Model Years)

- ALR — Switchable Automatic Locking Retractor
- CINCH — Cinching Latch Plate
-  Lower Anchorage Symbol (2 Anchorages Per Seating Position)
-  Top Tether Anchorage Symbol

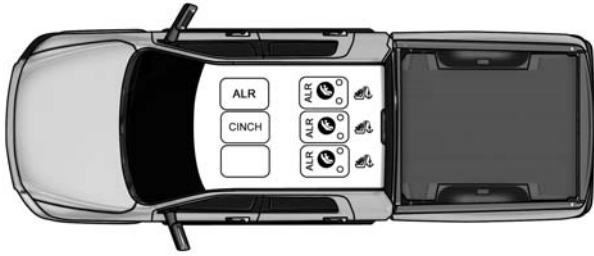

0226082970

Mega Cab (2006–2009 Model Years)

- ALR — Switchable Automatic Locking Retractor
- CINCH — Cinching Latch Plate
- Lower Anchorage Symbol (2 Anchorages Per Seating Position)
- Top Tether Anchorage Symbol

Locating The LATCH Lower Anchorages In This Vehicle

NOTE: 2001-2002 Dodge Ram 2500/3500 did not have lower anchorages.

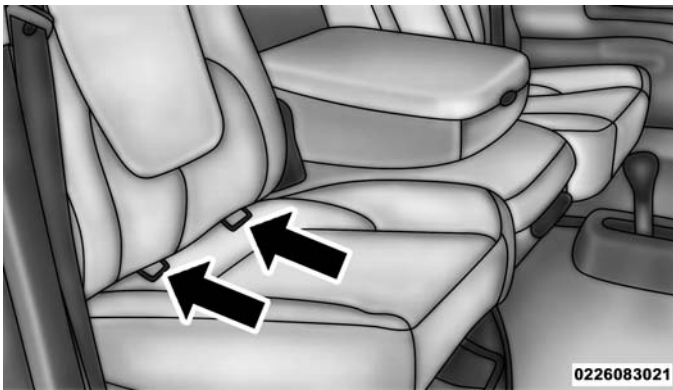

0226083021

Regular Cab Anchorages (2003–2009 Model Years)

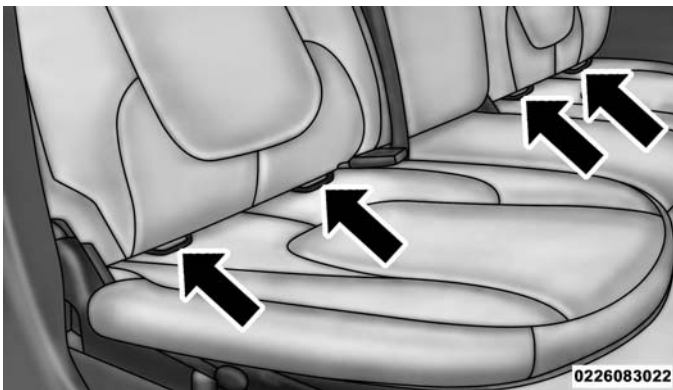

0226083022

Quad Cab Anchorages (2003–2009 Model Years)

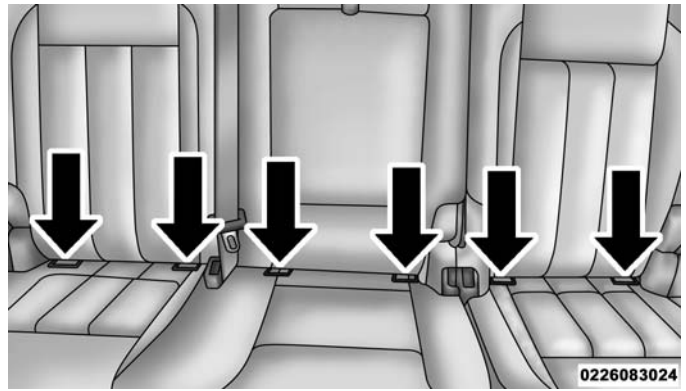

0226083024

Mega Cab Anchorages (2006-2009 Model Years)

Locating The Tether Anchorages In This Vehicle



2001–2002 Model Years

Regular Cab models have tether strap anchorages behind the front center and right seats

Quad Cab models have tether strap anchorages located behind each of the rear seats.

The Quad Cab model without a rear seat (rear seat delete option) has an anchorage for the center seat on the rear panel of the cab behind the center front seat, and an anchorage for the right passenger seat on the inboard seat adjuster.

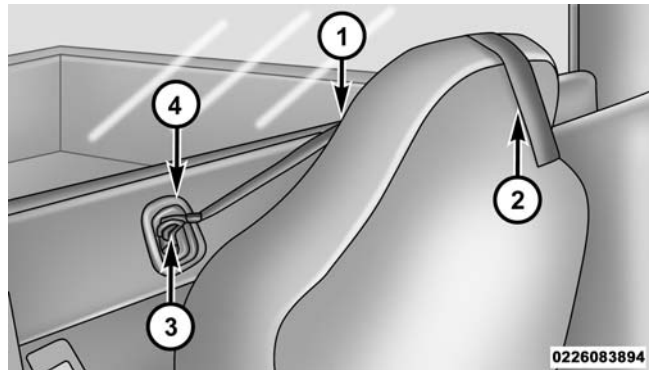

0226083894

Regular Cab, Center And Right Front Seat (2001-2002 Model Years)

1. Tether Strap
2. Tether Strap To Child Restraint
3. Tether Strap Anchorage
4. Tether Strap Hook

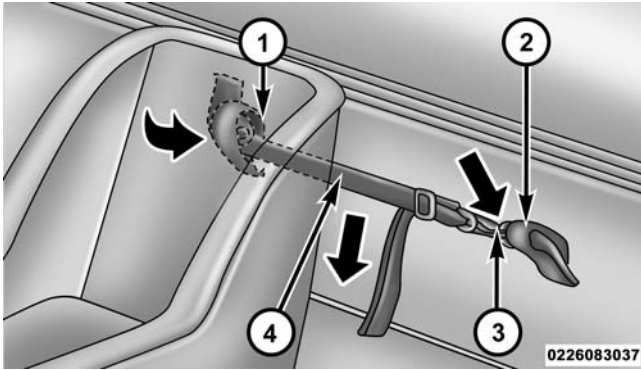

Quad Cab Rear Seats (2001-2002 Model Years)

1. Anchor Strap Loop
2. Anchor Strap Metal Ring
3. Tether Strap Hook
4. Tether Strap

2003–2009 Model Years

Regular Cab models have tether strap anchorages behind the front center and right seats. Quad Cab and Mega Cab models have tether strap anchorages located behind each of the rear seats.

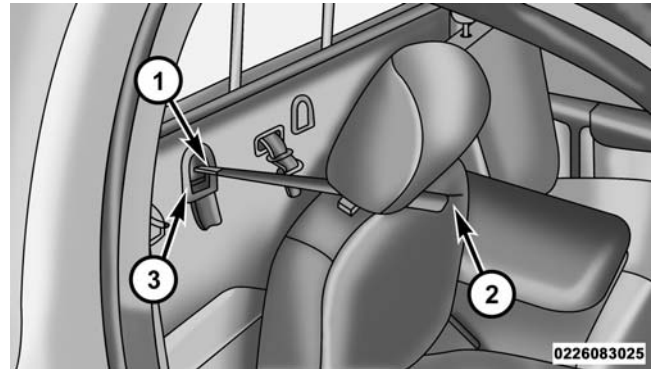

Regular Cab Tether Anchorages (2003-2009 Model Years)

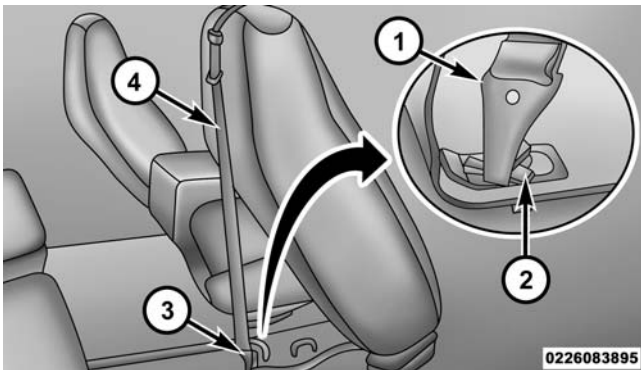

Quad Cab Front Passenger, With Rear Seat Delete Option (2001-2002 Model Years)

1. Tether Strap Hook
2. Tether Anchorage
3. Tether Strap Hook
4. Tether Strap

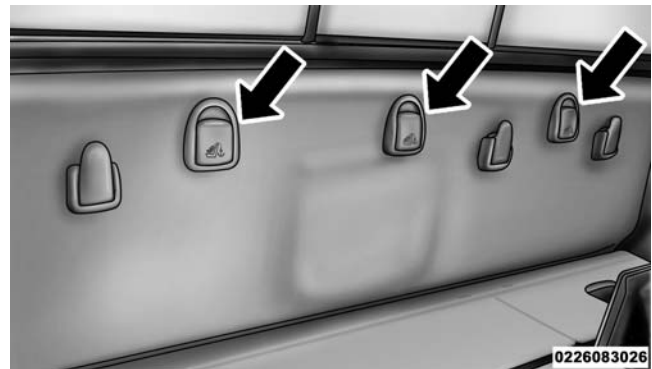

Mega Cab Tether Anchorages (2006-2009 Model Years)

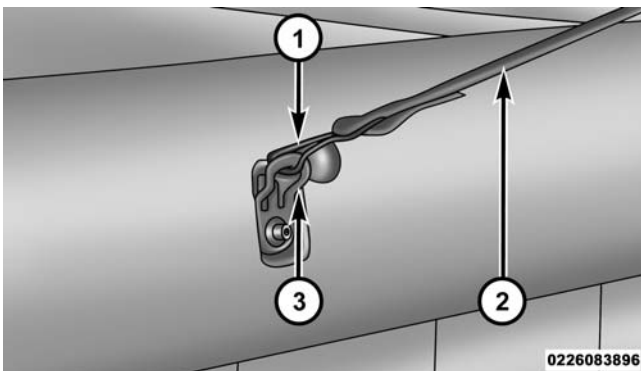

Quad Cab Front Center, With Rear Seat Delete Option (2001-2002 Model Years)

1. Tether Strap Hook
2. Tether Strap
3. Tether Anchorage



Quad Cab Tether Anchorages (2003-2009 Model Years)

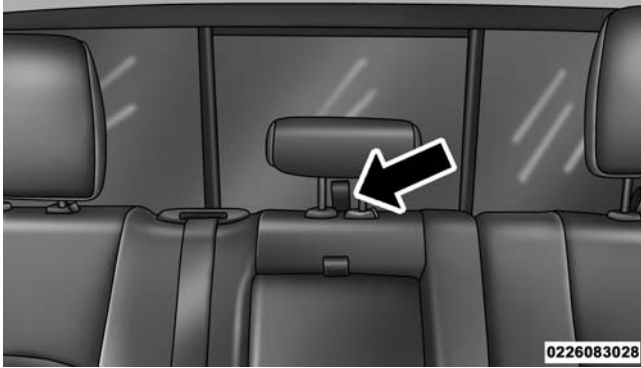

Quad Cab Tether Anchorages (2003-2009 Model Years)

Frequently Asked Questions About LATCH		
What is the weight limit (child's weight + weight of the child restraint) for using the LATCH anchorage system to attach the child restraint?	65 lbs (29.5 kg)	Use the LATCH anchorage system until the combined weight of the child and the child restraint is 65 lbs (29.5 kg). Use the seat belt alone instead of the LATCH anchorage system once the combined weight is more than 65 lbs (29.5 kg).
Can the LATCH anchorages and the seat belt be used together to attach a rear-facing or forward-facing child restraint?	No	Do not use the seat belt when you use the LATCH anchorage system to attach a rear-facing or forward-facing child restraint.
Can two child restraints be attached using a common lower LATCH anchorage?	No	Never "share" a LATCH anchorage with two or more child restraints. If the center position does not have dedicated LATCH lower anchorages, use the seat belt to install a child seat in the center position next to a child seat using the LATCH anchorages in an outboard position.
Can the rear-facing child restraint touch the back of the front passenger seat?	Yes	The child seat may touch the back of the front passenger seat if the child restraint manufacturer also allows contact. See your child restraint owner's manual for more information.
Can the head restraints be removed?	No	
Quad Cab, 2003–2009 Model Years		
Can a child seat be installed in the center position using the inner LATCH lower anchorages?	No	Use the seat belt and tether anchor to install a child seat in the center seating position.

Center Seat LATCH

Quad Cab (2003–2009 Model Years)

WARNING!
<ul style="list-style-type: none"> • Do not install a child restraint in the center position using the LATCH system. This position is not approved for installing child seats using the LATCH attachments. You must use the seat belt and tether anchor to install a child seat in the center seating position. • Never use the same lower anchorage to attach more than one child restraint. Please refer to "Installing Child Restraints Using the LATCH Lower Anchorages" in the section "Installing Child Restraints" for typical installation instructions.

Mega Cab (2006-2009 Model Years)

If a child restraint installed in the center position blocks the seat belt webbing or buckle for the outboard position, do not use that outboard position. If a child seat in the center

position blocks the outboard LATCH anchors or seat belt, do not install a child seat in that outboard position.

WARNING!
<p>Never use the same lower anchorage to attach more than one child restraint. Please refer to "Installing Child Restraints Using the LATCH Lower Anchorages" in the section "Installing Child Restraints" for typical installation instructions.</p>

Directions For Attaching The Tether Anchorage

2001–2002 Model Years

Regular Cab, Center and Right Front Seats (2001-2002 Model Years)

1. Place the child restraint on the front passenger or center seat.
2. Route the tether strap over the top of the vehicle seat and back to the tether anchorage on the back of the cab.

3. Lift the cover (if equipped with one) and attach the tether strap hook of the child restraint to the top tether anchorage as shown in the diagram.
4. Remove slack in the tether strap according to the child restraint manufacturer's instructions.

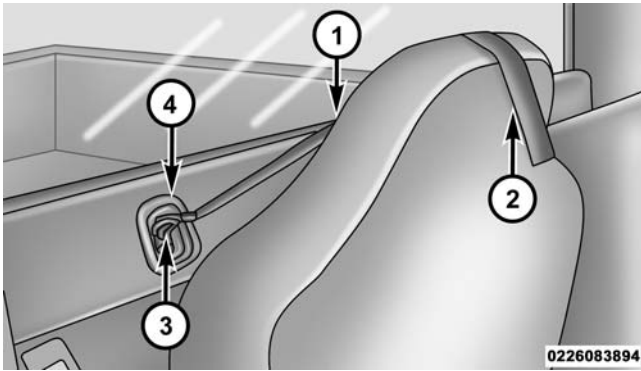

Regular Cab, Center And Right Front Seat (2001-2002 Model Years)

1. Tether Strap
2. Tether Strap to Child Restraint
3. Tether Anchorage
4. Tether Strap Hook

Quad Cab, Front Passenger Seat, Rear Seat Delete Option (2001-2002 Model Years)

1. Place the child restraint on the front passenger seat.
2. Route the tether strap over the top of the vehicle seat and down to the tether anchorage located at the bottom rear of the seat, on the inboard seat adjuster.
3. Attach the tether strap hook of the child restraint to the top tether anchorage as shown in the diagram.
4. Remove slack in the tether strap according to the child restraint manufacturer's instructions.

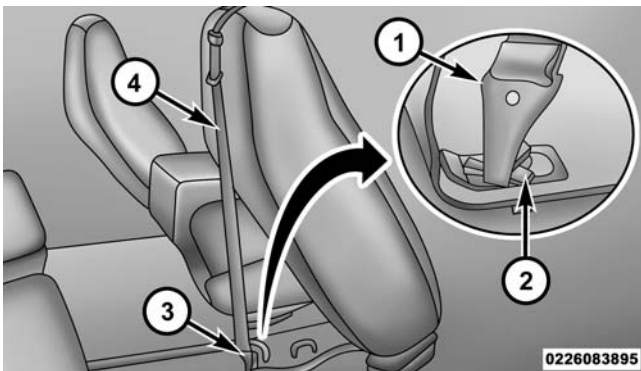

Quad Cab Front Passenger, With Rear Seat Delete Option (2001-2002 Model Years)

1. Tether Strap Hook
2. Tether Anchorage
3. Tether Strap Hook
4. Tether Strap

Quad Cab, Center Front Seat , Rear Seat Delete Option (2001-2002 Model Years)

1. Place the child restraint on the front center seat.
2. Route the tether strap over the top of the vehicle seat and back to the tether anchorage on the back of the cab.
3. Lift the cover (if equipped with one) and attach the tether strap hook of the child restraint to the top tether anchorage as shown in the diagram.
4. Remove slack in the tether strap according to the child restraint manufacturer's instructions.

WARNING!
Never place a rear-facing child restraint in front of an air bag. A deploying passenger Front Air Bag can cause death or serious injury to a child 12 years or younger, including a child in a rear-facing child restraint.

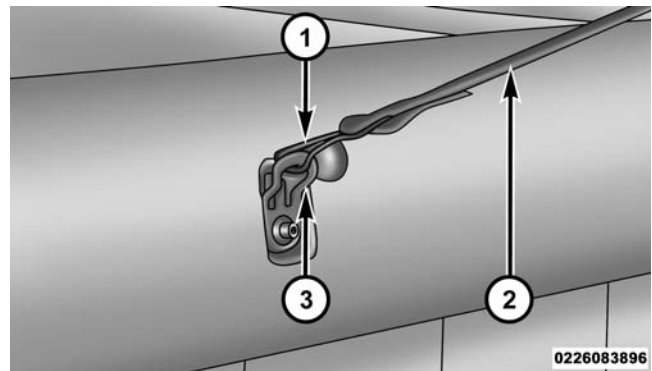

Quad Cab Front Center, With Rear Seat Delete Option (2001-2002 Model Years)

1. Tether Strap Hook
2. Tether Strap
3. Tether Anchorage

WARNING!
Never place a rear-facing child restraint in front of an air bag. A deploying passenger Front Air Bag can cause death or serious injury to a child 12 years or younger, including a child in a rear-facing child restraint.

Regular Cab/Mega Cab (2003–2009 Model Years)

In the regular cab truck, the top tether anchorages are located behind the center and right passenger seats. In the mega cab truck, the top tether anchorages are located behind each rear seating position. There is a plastic cover over each anchorage. To attach the tether strap of the child restraint:

1. Place the child restraint on the seat and adjust the tether strap so that it will reach over the seat back, under the head restraint and to the tether anchor directly behind the seat.

- Route the tether strap to provide the most direct path between the anchorage and the child seat. The tether strap should go between the head restraint posts underneath the head restraint. You may need to adjust the head restraint to the upward position to pass the tether strap underneath the head restraint and between its posts.
- Lift the cover (if so equipped), and attach the hook to the square opening in the sheet metal.
- Tighten the tether strap according to the child seat manufacturer's instructions.

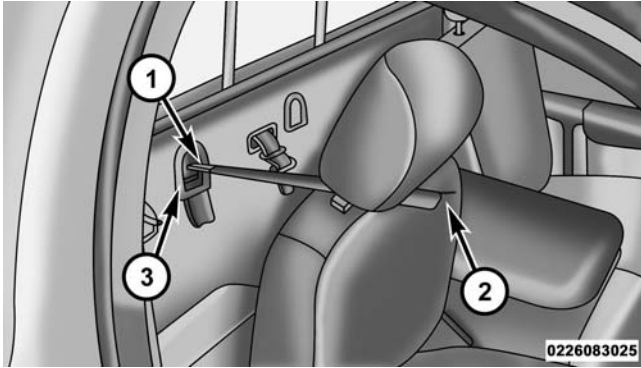

Regular Cab Tether Anchorages (2003-2009 Model Years)

- Tether Strap
- Tether Strap To Child Restraint
- Tether Anchorage

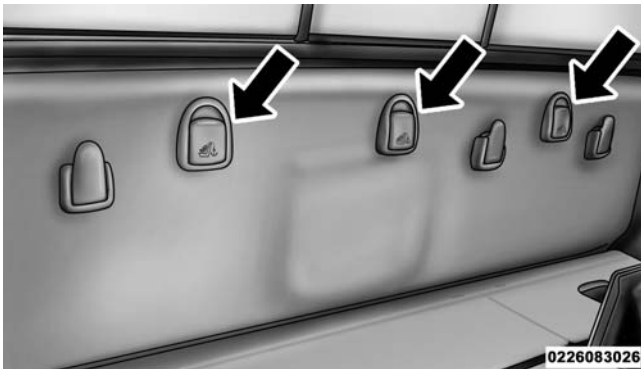

Mega Cab Tether Anchorages (2006-2009 Model Years)

WARNING!

Never place a rear-facing child restraint in front of an air bag. A deploying passenger Advanced Front Air Bag can cause death or serious injury to a child 12 years or younger, including a child in a rear-facing child restraint.

Quad Cab (2001-2009 Model Years)

The top tether anchorages in this vehicle are tether strap loops located between the rear glass and the back of the rear seat. There is a tether strap loop located behind each seating position. Follow the steps below to attach the tether strap of the child restraint.

Right or Left Outboard Seats:

- Raise the head restraint and reach between the rear seat and rear glass to access the tether strap loop.

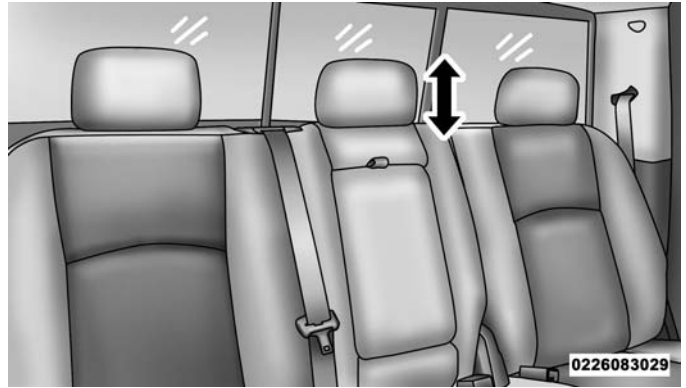

- Place a child restraint on the seat and adjust the tether strap so that it will reach over the seat back, under the head restraint, through the tether strap loop behind the seat and over to the anchorage behind the center seat.
- Pass the tether strap hook under the head restraint behind the child seat, through the tether strap loop behind the seat and over to the center tether anchorage.
- Attach the tether strap hook to the center anchor strap metal ring (see diagram).
- Tighten the tether strap according to the child seat manufacturer's instructions.

NOTE: If there are child seats in both of the outboard (left and right) seating positions, the tether strap hooks of both child seats should be connected to the center anchor strap metal ring. This is the correct way to tether two outboard child seats.

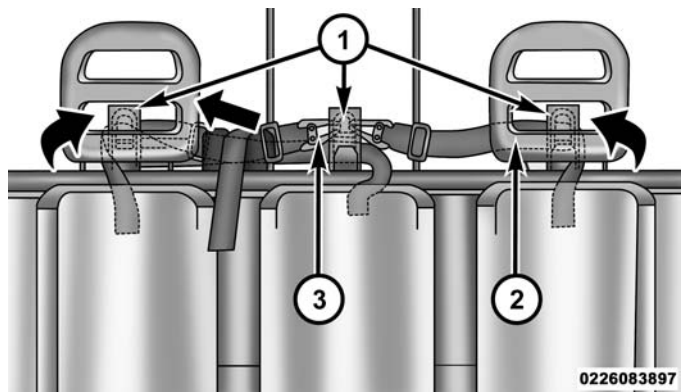

Multiple Child Restraints, Quad Cab (2001-2009 Model Years)

- Anchor Strap Metal Ring(s)
- Tether Strap
- Tether Strap Hook

Center Seat:

- Raise the head restraint and reach between the rear seat and rear glass to access the tether strap loop.

2. Place a child restraint on the seat and adjust the tether strap so that it will reach over the seat back, under the head restraint, through the tether strap loop behind the seat and over to the anchorage behind the passenger side outboard seat.
3. Pass the tether strap hook under the head restraint behind the child seat, through the tether strap loop behind the seat and over to the right outboard tether anchorage.
4. Attach the tether strap hook to the anchor strap metal ring behind the right outboard seating position.
5. Tighten the tether strap according to the child seat manufacturer's instructions.

Installing Three Child Restraints:

1. Place a child restraint on each outboard rear seat. Route the tether straps following the directions for right and left seating positions, above.
2. Attach both tether strap hooks to the center anchor strap metal ring, but do not tighten the straps yet
3. Place a child restraint on the center rear seat. Route the tether strap following the directions for the center seating position, above.
4. Attach the tether strap hook to the outboard anchor strap metal ring.
5. Tighten the tether straps according to the child seat manufacturer's instructions, tightening the right and left tether straps before the center tether strap.

WARNING!
<ul style="list-style-type: none"> • An incorrectly anchored tether strap could lead to increased head motion and possible injury to the child. Use only the anchorage position directly behind the child seat to secure a child restraint top tether strap. • If your vehicle is equipped with a split rear seat, make sure the tether strap does not slip into the opening between the seatbacks as you remove slack in the strap.

Seat Belt Systems In Your Vehicle

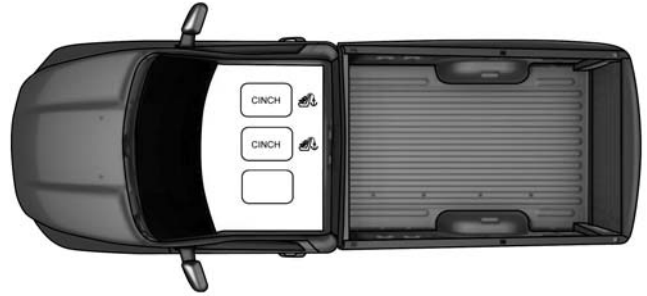

0226082965

Regular Cab (2001–2002 Model Years)

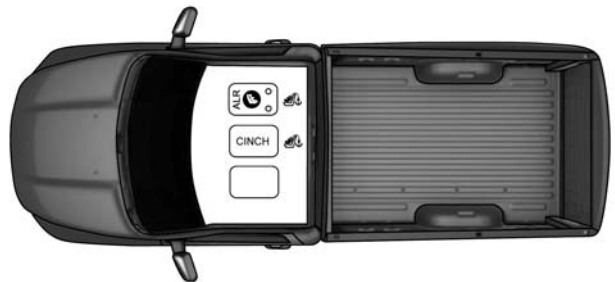

0226082967

Regular Cab (2003–2005 Model Years)

- ALR — Switchable Automatic Locking Retractor
- CINCH — Cinching Latch Plate
- Lower Anchorage Symbol (2 Anchorages Per Seating Position)
- Top Tether Anchorage Symbol

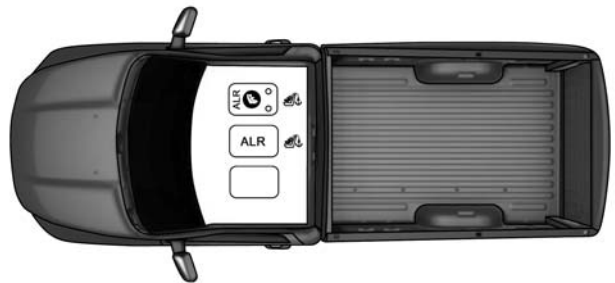

0226082968

Regular Cab (2006–2009 Model Years)

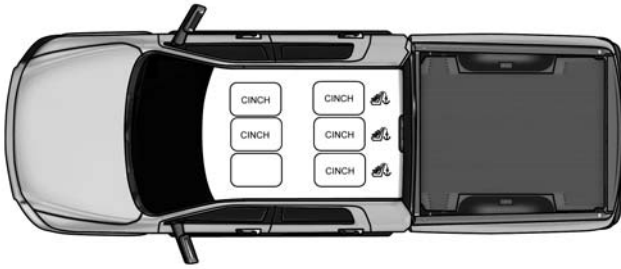

0226082964

Quad Cab (2001–2002 Model Years)

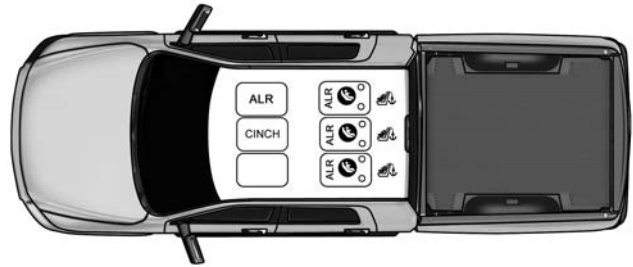

0226082970

Mega Cab (2006–2009 Model Years)

- ALR — Switchable Automatic Locking Retractor
- CINCH — Cinching Latch Plate
- Lower Anchorage Symbol (2 Anchorages Per Seating Position)
- Top Tether Anchorage Symbol

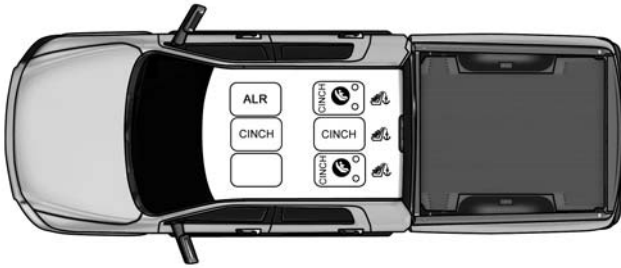

0226082966

Quad Cab (2003–2005 Model Years)

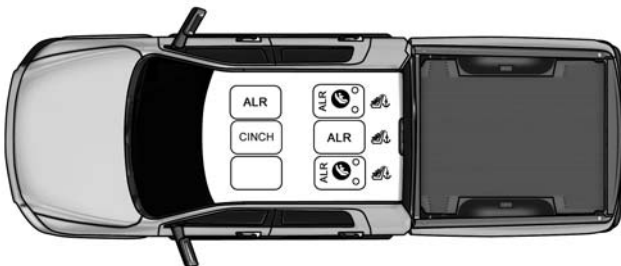

0226082971

Quad Cab (2006–2009 Model Years)

Frequently Asked Questions About Seat Belts And Car Seats

What is the weight limit (child’s weight + weight of the child restraint) for using the Tether Anchor with the seat belt to attach a forward facing child restraint?	65 lbs (29.5 kg)	The Tether Anchor can be used with the seat belt until the combined weight of the child and the child restraint is 65 lbs (29.5 kg). Use the seat belt without the Tether Anchor once the combined weight is more than 65 lbs (29.5 kg).
Can the rear-facing child restraint touch the back of the front passenger seat?	Yes	Contact between the front passenger seat and the child restraint is allowed, if the child restraint manufacturer also allows contact.
Can the head restraints be removed?	No	
Can the buckle stalk be twisted to tighten the seat belt against the belt path of the child restraint?	Yes	In positions with cinching latch plates (CINCH), the buckle stalk may be twisted up to 3 full turns. Do not twist the buckle stalk in a seating position with an ALR retractor.

DODGE RAM CHASSIS CAB, 2007–2010

LATCH And Tethers In Your Vehicle

LATCH Positions For Installing Child Restraints In This Vehicle

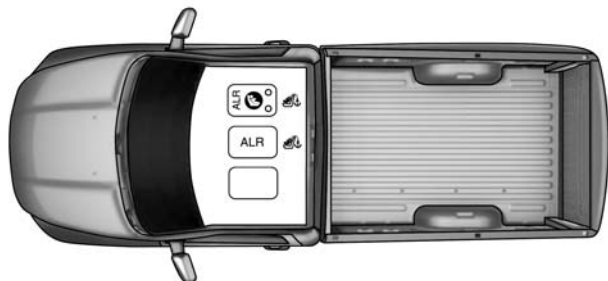

0226082974

Regular Cab (2007–2009 Model Years)



0226082975

Quad Cab Full Bench (2007–2009 Model Years)

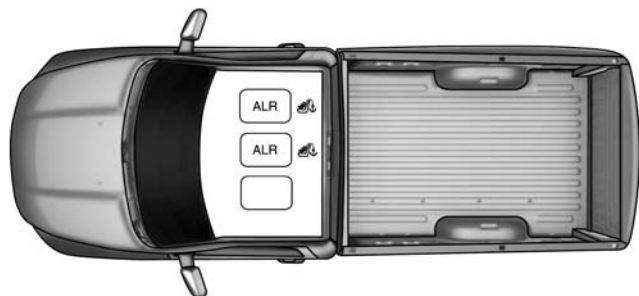

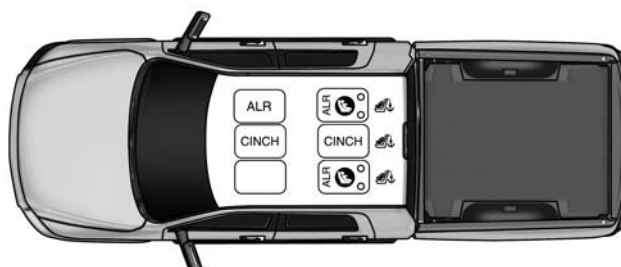

0226082961

Regular Cab (2010 Model Year)



0226082978

Quad Cab Full Bench (2010 Model Year)

- ALR — Switchable Automatic Locking Retractor
- CINCH — Cinching Latch Plate
-  Lower Anchorage Symbol (2 Anchorages Per Seating Position)
-  Top Tether Anchorage Symbol

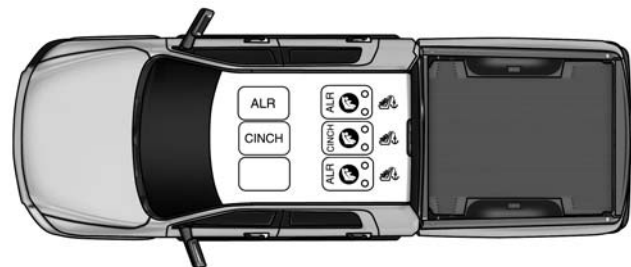

0226082963

Quad Cab Split Bench (2010 Model Year)

Locating The LATCH Lower Anchorages In This Vehicle

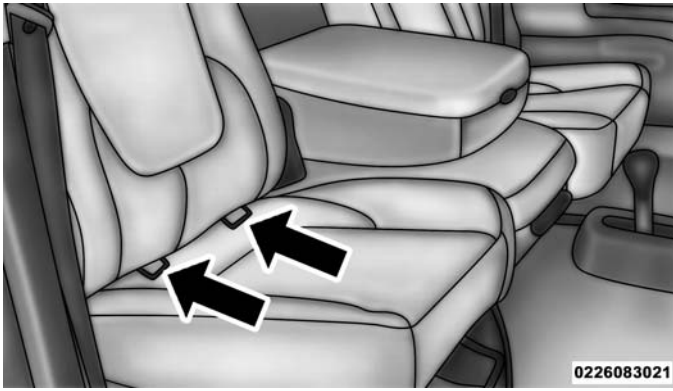

Regular Cab Anchorages (2007–2009 Model Years)

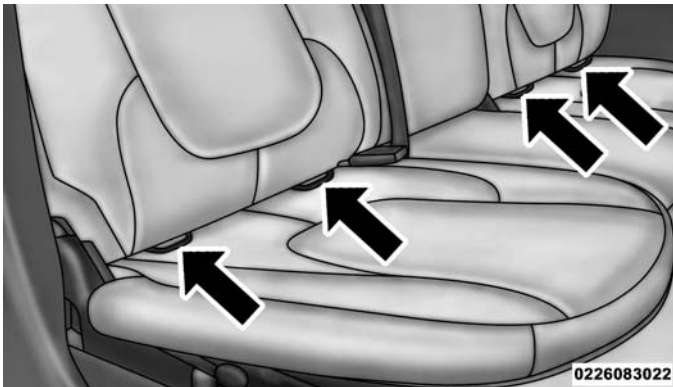

Quad Cab Full Bench Seat Lower Anchorages (2007–2010 Model Years)

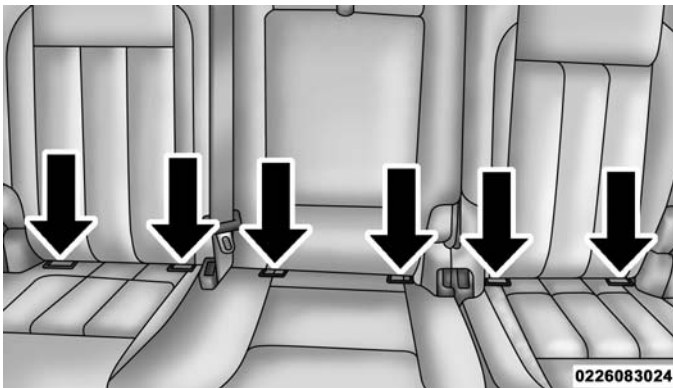

Quad Cab Split Bench Seat Lower Anchorages (2010 Model Year)

Locating The Tether Anchorages In This Vehicle



Regular Cab models have tether strap anchorages behind the front center and right seats. Quad Cab models have tether strap anchorages located behind each of the rear seats.

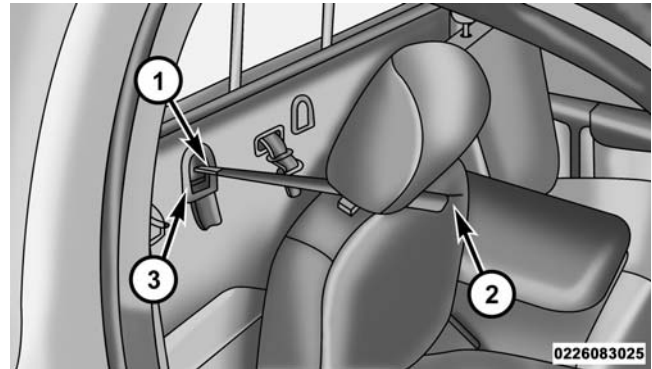

Regular Cab, Center & Right Front Seat (2007-2010 Model Years)

1. Tether Strap Hook
2. Tether Strap To Child Restraint
3. Tether Anchorage



Quad Cab Rear Seat Outboard Tether Anchorage (2007 - 2010 Model Years)



Quad Cab Rear Center Tether Anchorage (2007 - 2010 Model Years)

Frequently Asked Questions About LATCH		
What is the weight limit (child's weight + weight of the child restraint) for using the LATCH anchorage system to attach the child restraint?	65 lbs (29.5 kg)	Use the LATCH anchorage system until the combined weight of the child and the child restraint is 65 lbs (29.5 kg). Use the seat belt alone instead of the LATCH anchorage system once the combined weight is more than 65 lbs (29.5 kg).
Can the LATCH anchorages and the seat belt be used together to attach a rear-facing or forward-facing child restraint?	No	Do not use the seat belt when you use the LATCH anchorage system to attach a rear-facing or forward-facing child restraint.
Can two child restraints be attached using a common lower LATCH anchorage?	No	Never "share" a LATCH anchorage with two or more child restraints. If the center position does not have dedicated LATCH lower anchorages, use the seat belt to install a child seat in the center position next to a child seat using the LATCH anchorages in an outboard position.
Can the rear-facing child restraint touch the back of the front passenger seat?	Yes	The child seat may touch the back of the front passenger seat if the child restraint manufacturer also allows contact. See your child restraint owner's manual for more information.
Can the head restraints be removed?	No	
2007-2010 Model Year Quad Cab Full Bench		
Can a child seat be installed in the center position using the inner LATCH lower anchorages?	No	Use the seat belt and tether anchor to install a child seat in the center seating position.

Center Seat LATCH

Quad Cab Full Bench (2007–2010 Model Years)

WARNING!

- Do not install a child restraint in the center position using the LATCH system. This position is not approved for installing child seats using the LATCH attachments. You must use the seat belt and tether anchor to install a child seat in the center seating position.
- Never use the same lower anchorage to attach more than one child restraint. Please refer to "Installing Child Restraints Using the LATCH Lower Anchorages" in the section "Installing Child Restraints" for typical installation instructions.

Quad Cab Split Bench (2010 Model Year)

If a child restraint installed in the center position blocks the seat belt webbing or buckle for the outboard position, do not use that outboard position. If a child seat in the center position blocks the outboard LATCH anchors or seat belt, do not install a child seat in that outboard position.

WARNING!

Never use the same lower anchorage to attach more than one child restraint. Please refer to "Installing Child Restraints Using the LATCH Lower Anchorages" in the section "Installing Child Restraints" for typical installation instructions.

Directions For Attaching The Tether Anchorage

Regular Cab (2007–2010 Model Years)

In the regular cab truck, the top tether anchorages are located behind the center and right passenger seats. There is a plastic cover over each anchorage. To attach the tether strap of the child restraint:

1. Place the child restraint on the seat and adjust the tether strap so that it will reach over the seat back, under the head restraint and to the tether anchor directly behind the seat.
2. Route the tether strap to provide the most direct path between the anchorage and the child seat. The tether strap should go between the head restraint posts underneath the head restraint. You may need to adjust the head restraint to the upward position to pass the tether strap underneath the head restraint and between its posts.
3. Lift the cover (if so equipped), and attach the tether strap hook to the square opening in the sheet metal.
4. Tighten the tether strap according to the child seat manufacturer's instructions.

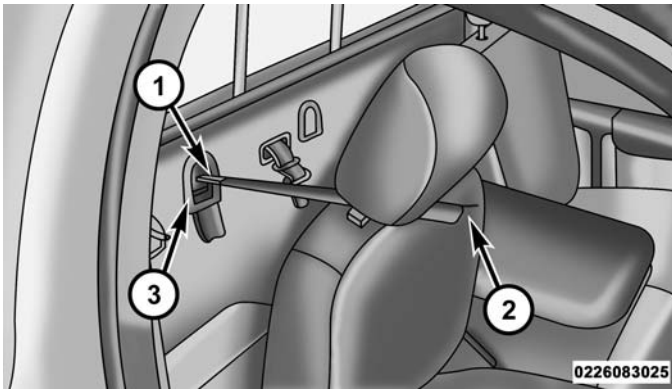

Regular Cab Tether Anchorages (2007-2010 Model Years)

WARNING!

Never place a rear-facing child restraint in front of an air bag. A deploying passenger Advanced Front Air Bag can cause death or serious injury to a child 12 years or younger, including a child in a rear-facing child restraint.

Quad Cab (2007–2010 Model Years)

The top tether anchorages in this vehicle are tether strap loops located between the rear glass and the back of the rear seat. There is a tether strap loop located behind each seating position. Follow the steps below to attach the tether strap of the child restraint.

Right or Left Outboard Seats:

1. Raise the head restraint and reach between the rear seat and rear glass to access the tether strap loop.

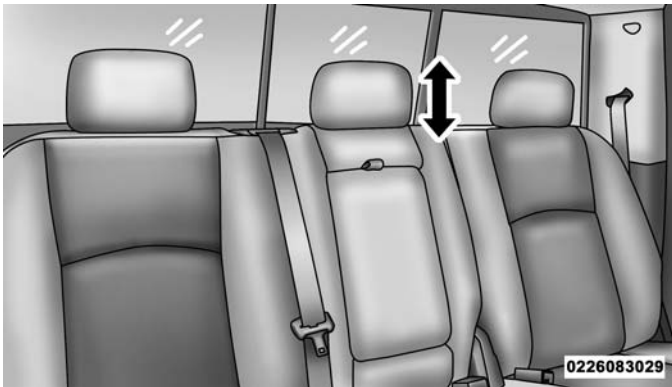

Head Restraint In Raised Position

2. Place a child restraint on the seat and adjust the tether strap so that it will reach over the seat back, under the head restraint, through the tether strap loop behind the seat and over to the anchorage behind the center seat.
3. Pass the tether strap hook under the head restraint behind the child seat, through the tether strap loop behind the seat and over to the center tether anchorage.

4. Attach the tether strap hook to the center anchor strap metal ring (see diagram).

5. Tighten the tether strap according to the child seat manufacturer's instructions.

NOTE: If there are child seats in both of the outboard (left and right) seating positions, the tether strap hooks of both child seats should be connected to the center anchor strap metal ring. This is the correct way to tether two outboard child seats.

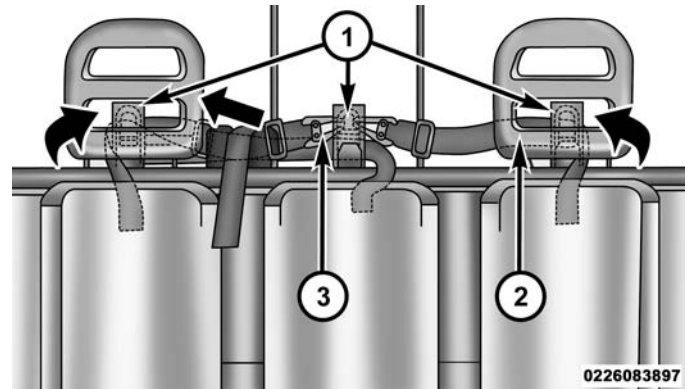

Multiple Child Restraints, Quad Cab (2007-2010 Model Years)

1. Anchor Strap Metal Ring(s)
2. Tether Strap
3. Tether Strap Hook

Center Seat:

1. Raise the head restraint and reach between the rear seat and rear glass to access the tether strap loop.
2. Place a child restraint on the seat and adjust the tether strap so that it will reach over the seat back, under the head restraint, through the tether strap loop behind the seat and over to the anchorage behind the passenger side outboard seat.
3. Pass the tether strap hook under the head restraint behind the child seat, through the tether strap loop behind the seat and over to the right outboard tether anchorage.
4. Attach the tether strap hook to the anchor strap metal ring behind the right outboard seating position.
5. Tighten the tether strap according to the child seat manufacturer's instructions.

Installing Three Child Restraints:

1. Place a child restraint on each outboard rear seat. Route the tether straps following the directions for right and left seating positions, above.
2. Attach both tether strap hooks to the center anchor strap metal ring, but do not tighten the straps yet.
3. Place a child restraint on the center rear seat. Route the tether strap following the directions for the center seating position, above.
4. Attach the tether strap hook to the outboard anchor strap metal ring.
5. Tighten the tether straps according to the child seat manufacturer’s instructions, tightening the right and left tether straps before the center tether strap.

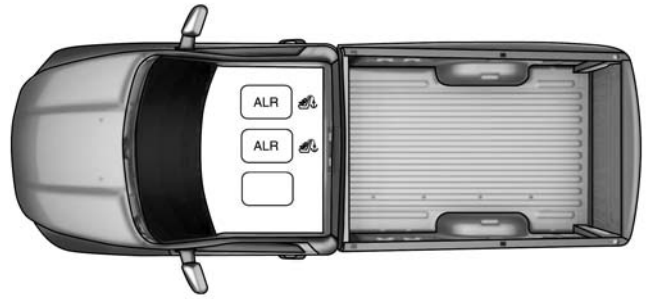

0226082961

Regular Cab (2010 Model Year)

WARNING!

- An incorrectly anchored tether strap could lead to increased head motion and possible injury to the child. Use only the anchorage position directly behind the child seat to secure a child restraint top tether strap.
- If your vehicle is equipped with a split rear seat, make sure the tether strap does not slip into the opening between the seatbacks as you remove slack in the strap.

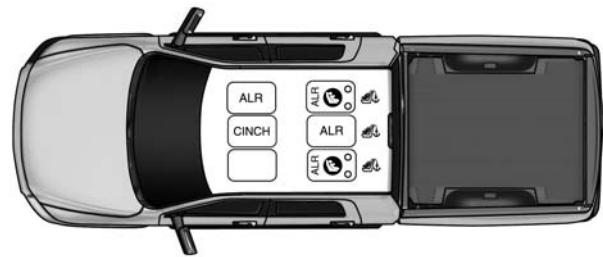

0226082975

Quad Cab Full Bench Seat (2007–2009 Model Years)

Seat Belt Systems In Your Vehicle

- ALR — Switchable Automatic Locking Retractor
- Lower Anchorage Symbol (2 Anchorages Per Seating Position)
- Top Tether Anchorage Symbol
- CINCH = Cinching Latch Plate

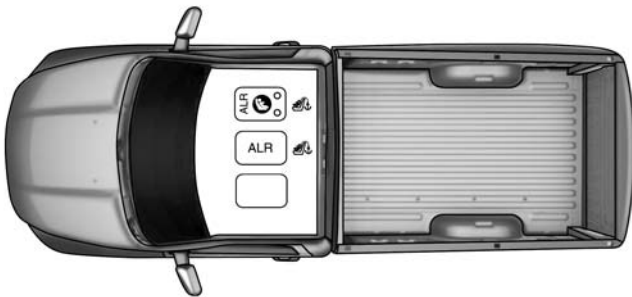

0226082974

Regular Cab (2007–2009 Model Years)

- ALR — Switchable Automatic Locking Retractor
- Lower Anchorage Symbol (2 Anchorages Per Seating Position)
- Top Tether Anchorage Symbol
- CINCH = Cinching Latch Plate

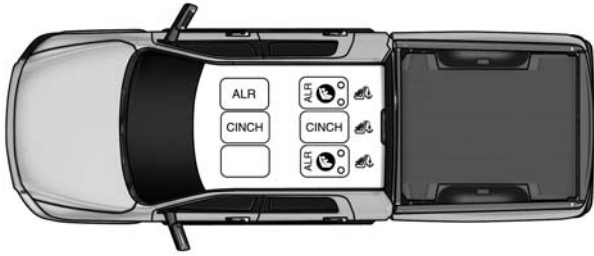

0226082978

Quad Cab Full Bench Seat (2010 Model Year)

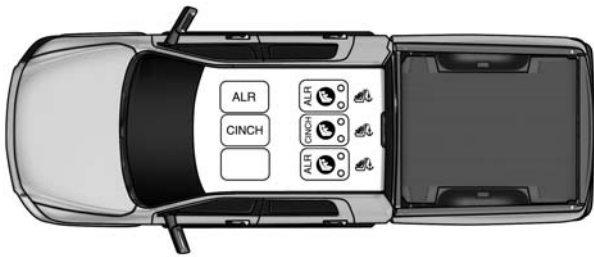

0226082963

Quad Cab Split Bench Seat (2010 Model Year)

Frequently Asked Questions About Seat Belts And Car Seats		
What is the weight limit (child's weight + weight of the child restraint) for using the Tether Anchor with the seat belt to attach a forward facing child restraint?	65 lbs (29.5 kg)	Use the LATCH anchorage system until the combined weight of the child and the child restraint is 65 lbs (29.5 kg). Use the seat belt alone instead of the LATCH anchorage system once the combined weight is more than 65 lbs (29.5 kg).
Can the rear-facing child restraint touch the back of the front passenger seat?	Yes	Contact between the front passenger seat and the child restraint is allowed, if the child restraint manufacturer also allows contact.
Can the head restraints be removed?	No	
Can the buckle stalk be twisted to tighten the seat belt against the belt path of the child restraint?	Yes	In positions with cinching latch plates (CINCH), the buckle stalk may be twisted up to 3 full turns. Do not twist the buckle stalk in a seating position with an ALR retractor.

INSTALLING CHILD RESTRAINTS IN YOUR VEHICLE — RAM

CONTENTS

■ RAM 1500, 2010–201351	□ Directions For Attaching The Tether Anchorage58
□ LATCH And Tethers In Your Vehicle51	□ Seat Belt Systems In Your Vehicle60
□ Center Seat LATCH52	■ RAM CHASSIS CAB, 2011–201362
□ Directions For Attaching The Tether Anchorage:53	□ LATCH And Tethers In Your Vehicle62
□ Seat Belt Systems In Your Vehicle54	□ Center Seat LATCH63
■ RAM 2500/3500, 2010–201356	□ Directions For Attaching The Tether Anchorage:64
□ LATCH And Tethers In Your Vehicle56	□ Seat Belt Systems In Your Vehicle65
□ Center Seat LATCH58		

RAM 1500, 2010–2013

LATCH And Tethers In Your Vehicle

LATCH Positions For Installing Child Restraints In This Vehicle

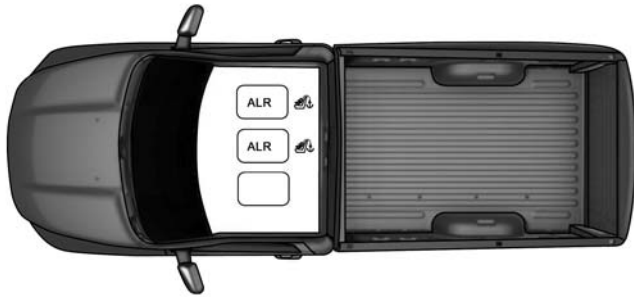

0226059225

Regular Cab (2010–2013 Model Years)

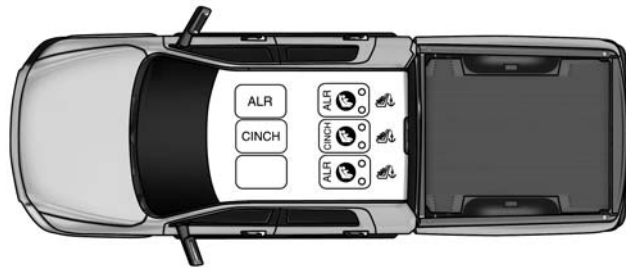

0226082963

Quad Cab/Crew Cab, Split Bench (2010–2013 Model Years)

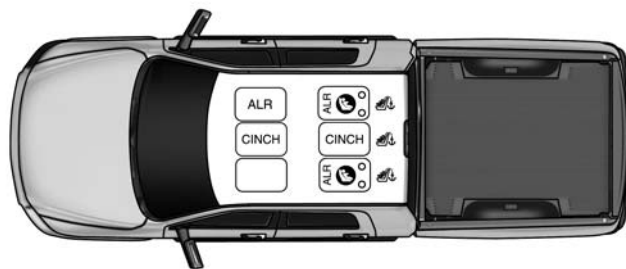

0226082962

Quad Cab/Crew Cab, Full Bench (2010–2013 Model Years)

- ALR — Switchable Automatic Locking Retractor
- Lower Anchorage Symbol (2 Anchorages Per Seating Position)
- Top Tether Anchorage Symbol
- CINCH = Cinching Latch Plate

Locating The LATCH Lower Anchorages In This Vehicle

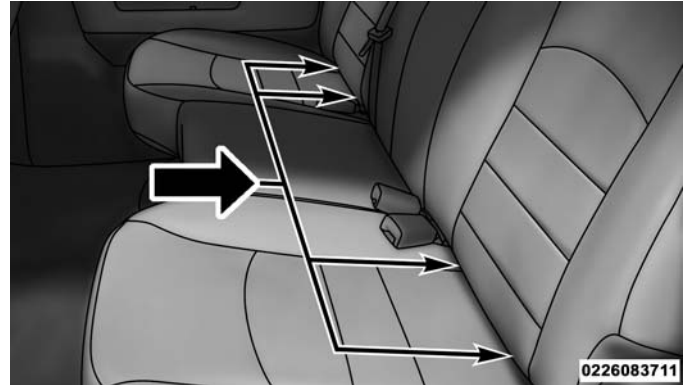

0226083711

Quad Cab/Crew Cab Full Bench Rear Seat (2010-2013 Model Years)

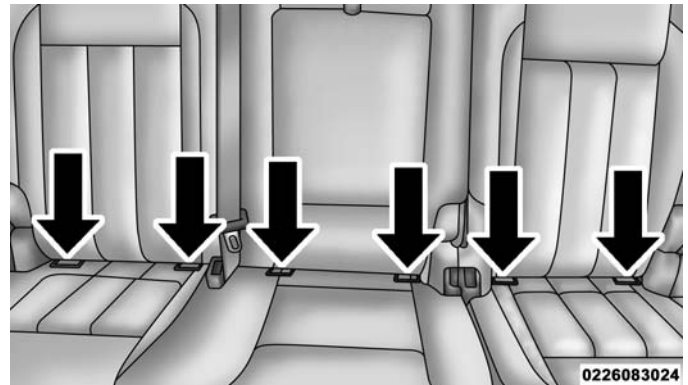

0226083024

Quad Cab/Crew Cab Split Bench Seat (2010-2013 Model Years)

Locating The Tether Anchorages In This Vehicle



Regular Cab models have tether strap anchorages behind the front center and right seats

Quad Cab and Crew Cab models have tether strap anchorages located behind each of the rear seats.

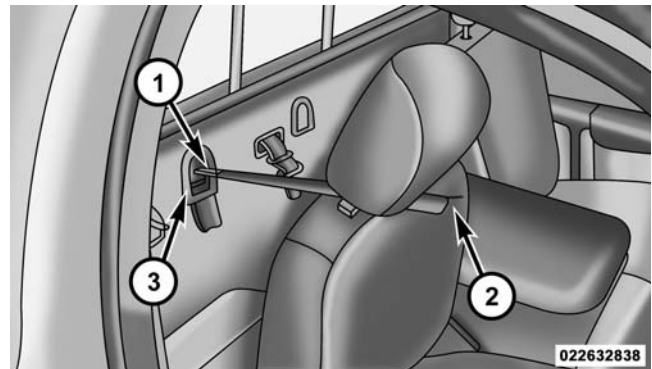

022632838

Regular Cab Tether Anchorages (2010-2013 Model Years)

1. Tether Strap Hook
2. Tether Strap To Child Restraint
3. Tether Anchorage



Quad Cab/Crew Cab Tether Anchorages
(2010-2013 Model Years)

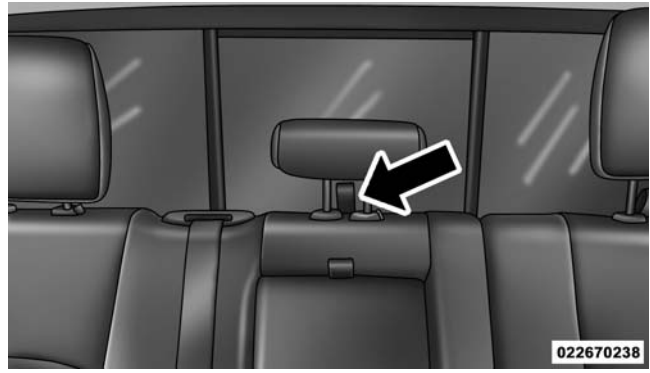

Quad Cab/Crew Cab Tether Anchorages
(2010-2013 Model Years)

Frequently Asked Questions About LATCH

What is the weight limit (child’s weight + weight of the child restraint) for using the LATCH anchorage system to attach the child restraint?	65 lbs (29.5 kg)	Use the LATCH anchorage system until the combined weight of the child and the child restraint is 65 lbs (29.5 kg). Use the seat belt and tether anchor instead of the LATCH system once the combined weight is more than 65 lbs (29.5 kg).
Can the LATCH anchorages and the seat belt be used together to attach a rear-facing or forward-facing child restraint?	No	Do not use the seat belt when you use the LATCH anchorage system to attach a rear-facing or forward-facing child restraint.
Can two child restraints be attached using a common lower LATCH anchorage?	No	Never “share” a LATCH anchorage with two or more child restraints. If the center position does not have dedicated LATCH lower anchorages, use the seat belt to install a child seat in the center position next to a child seat using the LATCH anchorages in an outboard position.
Can the rear-facing child restraint touch the back of the front passenger seat?	Yes	Contact between the front passenger seat and the child restraint is allowed, if the child restraint manufacturer also allows contact.
Can the head restraints be removed?	No	
2010-2013 Model Year Quad Cab/Crew Cab, Full Bench Seat		
Can a child seat be installed in the center position using the inner LATCH lower anchorages?	No	Use the seat belt and tether anchor to install a child seat in the center seating position.

Center Seat LATCH

Quad Cab/Crew Cab Split Bench (2010–2013 Model Years)

If a child restraint installed in the center position blocks the seat belt webbing or buckle for the outboard position, do not use that outboard position. If a child seat in the center position blocks the outboard LATCH anchors or seat belt, do not install a child seat in that outboard position.

WARNING!

Never use the same lower anchorage to attach more than one child restraint. Please refer to “Installing Child Restraints Using the LATCH Lower Anchorages” in the section “Installing Child Restraints” for typical installation instructions.

Quad Cab/Crew Cab Full Bench (2010–2013 Model Years)

WARNING!

- Do not install a child restraint in the center position using the LATCH system. This position is not approved for installing child seats using the LATCH attachments. You must use the seat belt and tether anchor to install a child seat in the center seating position.
- Never use the same lower anchorage to attach more than one child restraint. Please refer to “Installing Child Restraints Using the LATCH Lower Anchorages” in the section “Installing Child Restraints” for typical installation instructions.

Directions For Attaching The Tether Anchorage:

Regular Cab (2010–2013 Model Years)

In the regular cab truck, the top tether anchorages are located behind the center and right passenger seats. There is a plastic cover over each anchorage. To attach the tether strap of the child restraint:

1. Place the child restraint on the seat and adjust the tether strap so that it will reach over the seat back, under the head restraint and to the tether anchorage directly behind the seat.
2. Route the tether strap to provide the most direct path between the anchorage and the child seat. The tether strap should go between the head restraint posts underneath the head restraint. You may need to adjust the head restraint to the upward position to pass the tether strap underneath the head restraint and between its posts.
3. Lift the cover (if so equipped), and attach the hook to the square opening in the sheet metal.
4. Tighten the tether strap according to the child seat manufacturer’s instructions.

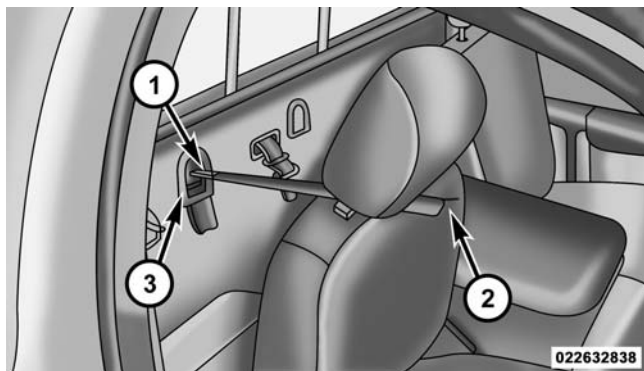

Regular Cab, Center And Right Front Seat (2010-2013 Years)

1. Tether Strap Hook
2. Tether Strap To Child Restraint
3. Tether Anchorage

WARNING!

Never place a rear-facing child restraint in front of an air bag. A deploying passenger Advanced Front Air Bag can cause death or serious injury to a child 12 years or younger, including a child in a rear-facing child restraint.

Quad Cab/Crew Cab Trucks (2010–2013 Model Years)

The top tether anchorages in this vehicle are tether strap loops located between the rear glass and the back of the rear seat. There is a tether strap loop located behind each seating position. Follow the steps below to attach the tether strap of the child restraint.

Right or Left Outboard Seats:

1. Raise the head restraint and reach between the rear seat and rear glass to access the tether strap loop.



2. Place a child restraint on the seat and adjust the tether strap so that it will reach over the seat back, under the head restraint, through the tether strap loop behind the seat and over to the tether strap loop behind the center seat.
3. Attach the hook to the center tether strap loop (see diagram).

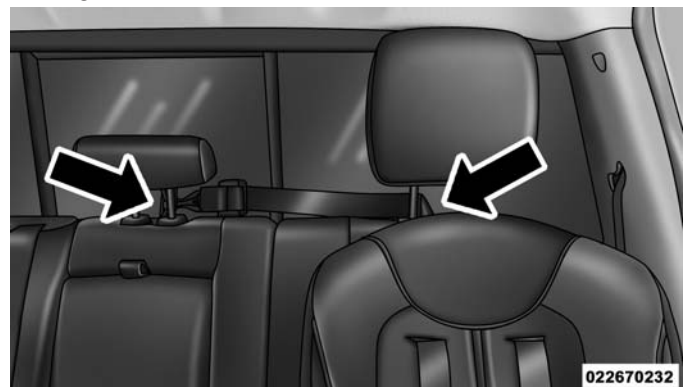

4. Tighten the tether strap according to the child seat manufacturer’s instructions.

NOTE: If there are child seats in both of the outboard (left and right) seating positions, the tether strap hooks of both child seats should be connected to the center tether strap loop. This is the correct way to tether two outboard child seats.

Center Seat:

1. Raise the head restraint and reach between the rear seat and rear glass to access the tether strap loop.

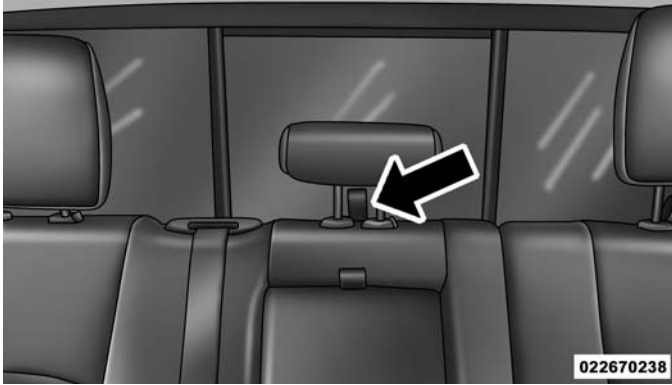

2. Place a child restraint on the seat and adjust the tether strap so that it will reach over the seat back, under the head restraint, through the tether strap loop behind the seat and over to the tether strap loop behind either the right or left outboard seat.
3. Pass the tether strap hook under the head restraint behind the child seat, through the tether strap loop behind the seat and over to the right or left outboard tether strap loop.

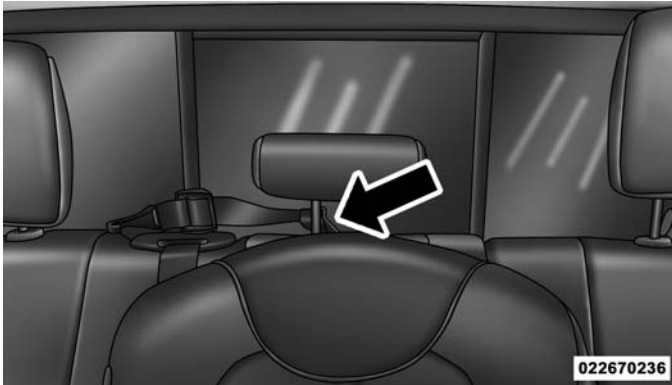

4. Attach the hook to the outboard tether strap loop (see diagram).

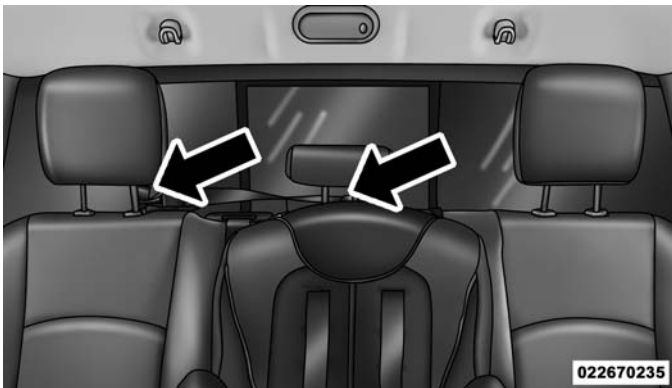

5. Tighten the tether strap according to the child seat manufacturer's instructions.

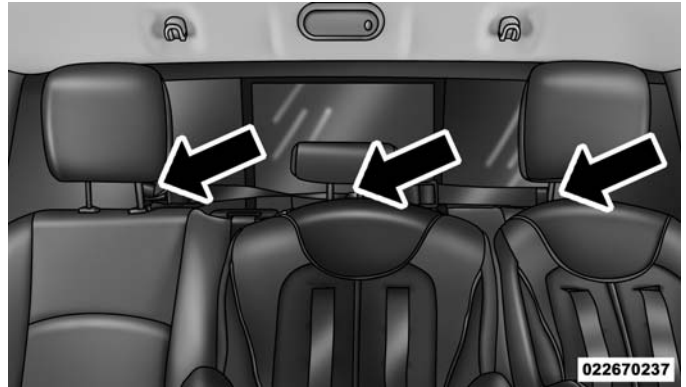

Installing Three Child Restraints:

1. Place a child restraint on each outboard rear seat. Route the tether straps following the directions for right and left seating positions, above.
2. Attach both hooks to the center tether strap loop, but do not tighten the straps yet.
3. Place a child restraint on the center rear seat. Route the tether strap following the directions for the center seating position, above.
4. Attach the hook to the outboard tether strap loop.
5. Tighten the tether straps according to the child seat manufacturer's instructions, tightening the right and left tether straps before the center tether strap.

**WARNING!**

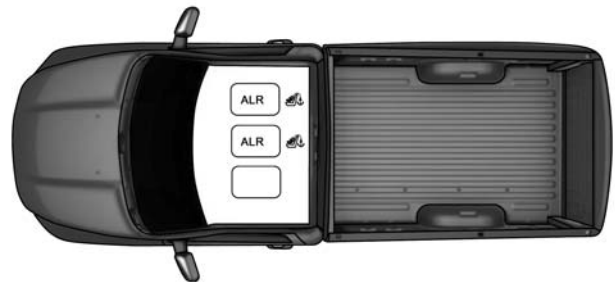
- An incorrectly anchored tether strap could lead to increased head motion and possible injury to the child. Use only the anchorage position directly behind the child seat to secure a child restraint top tether strap.
- If your vehicle is equipped with a split rear seat, make sure the tether strap does not slip into the opening between the seatbacks as you remove slack in the strap.

Seat Belt Systems In Your Vehicle**Regular Cab (2010–2013 Model Years)**

- ALR — Switchable Automatic Locking Retractor
-  Lower Anchorage Symbol (2 Anchorages Per Seating Position)
-  Top Tether Anchorage Symbol
- CINCH = Cinching Latch Plate

- ALR — Switchable Automatic Locking Retractor
- Lower Anchorage Symbol (2 Anchorages Per Seating Position)
- Top Tether Anchorage Symbol
- CINCH = Cinching Latch Plate

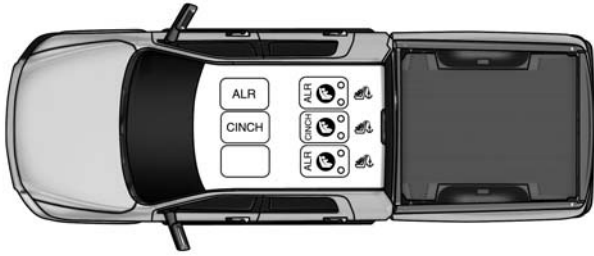

0226082963

Quad Cab/Crew Cab, Split Bench (2010–2013 Model Years)

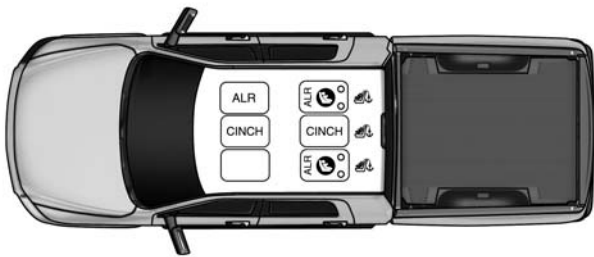

0226082962

Quad Cab/Crew Cab, Full Bench (2010–2013 Model Years)

Frequently Asked Questions About Seat Belts And Car Seats

What is the weight limit (child’s weight + weight of the child restraint) for using the Tether Anchor with the seat belt to attach a forward facing child restraint?	Weight limit of the Child Restraint	Always use the tether anchor when using the seat belt to install a forward facing child restraint, up to the recommended weight limit of the child restraint.
Can the rear-facing child restraint touch the back of the front passenger seat?	Yes	Contact between the front passenger seat and the child restraint is allowed, if the child restraint manufacturer also allows contact.
Can the head restraints be removed?	No	
Can the buckle stalk be twisted to tighten the seat belt against the belt path of the child restraint?	Yes	In positions with cinching latch plates (CINCH), the buckle stalk may be twisted up to 3 full turns. Do not twist the buckle stalk in a seating position with an ALR retractor.

WARNING!

Do not install a rear-facing car seat using a rear support leg in this vehicle. The floor of this vehicle is not designed to manage the crash forces of this type of car seat. In a crash, the support leg may not function as it was designed by the car seat manufacturer, and your child may be more severely injured as a result.

(Continued)

WARNING! (Continued)



0226047161

RAM 2500/3500, 2010–2013

LATCH And Tethers In Your Vehicle

LATCH Positions For Installing Child Restraints In This Vehicle

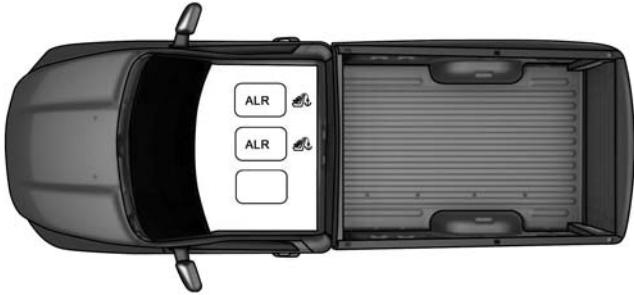

0226059225

Regular Cab (2010–2013 Model Years)

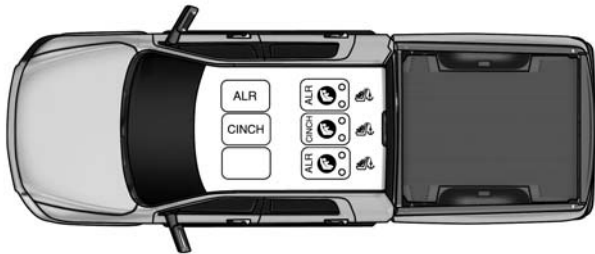

0226082963

Crew Cab/Mega Cab, Split Bench (2010–2013 Model Years)

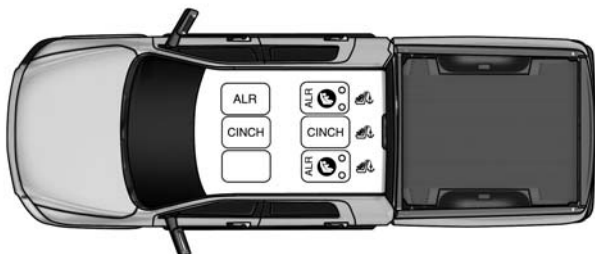

0226082962

Crew Cab, Full Bench (2010–2013 Model Years)

- ALR — Switchable Automatic Locking Retractor
- Lower Anchorage Symbol (2 Anchorages Per Seating Position)
- Top Tether Anchorage Symbol
- CINCH = Cinching Latch Plate

Locating The LATCH Lower Anchorages In This Vehicle

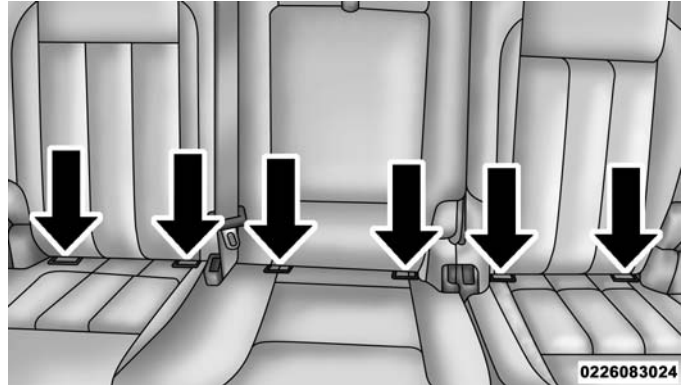

0226083024

Crew Cab/Mega Cab Split Bench Rear Seat (2010-2013)

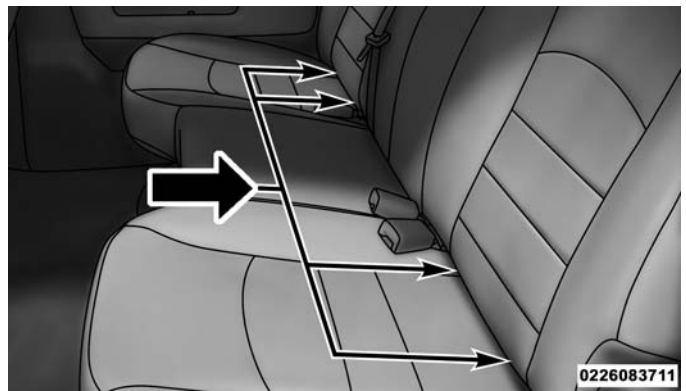

0226083711

Crew Cab Full Bench Seats (2010-2013)

Locating The Tether Anchorages In This Vehicle



Regular Cab models have tether strap anchorages behind the front center and right seats

Mega Cab and Crew Cab models have tether strap anchorages located behind each of the rear seats.

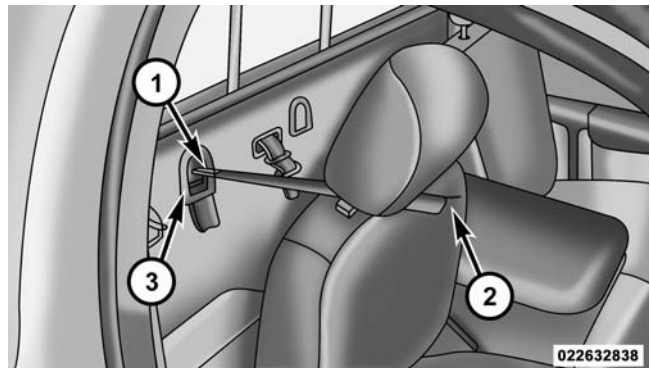

022632838

Regular Cab Tether Anchorages (2010-2013 Model Years)

1. Tether Strap Hook
2. Tether Strap To Child Restraint
3. Tether Anchorage

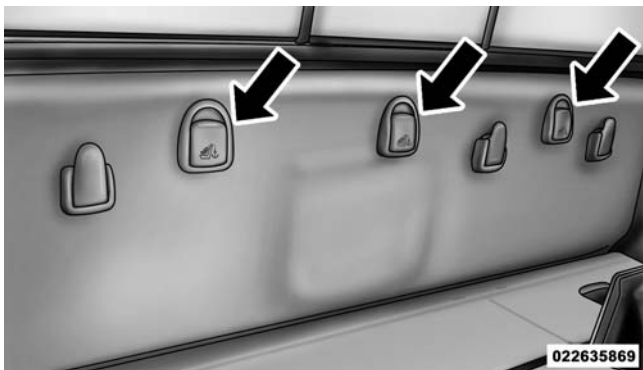

Mega Cab Tether Anchorages (2010-2013 Model Years)



Crew Cab Tether Anchorages (2010-2013 Model Years)



Crew Cab Tether Anchorages (2010-2013 Model Years)

Frequently Asked Questions About LATCH

What is the weight limit (child’s weight + weight of the child restraint) for using the LATCH anchorage system to attach the child restraint?	65 lbs (29.5 kg)	Use the LATCH anchorage system until the combined weight of the child and the child restraint is 65 lbs (29.5 kg). Use the seat belt and tether anchor instead of the LATCH system once the combined weight is more than 65 lbs (29.5 kg).
Can the LATCH anchorages and the seat belt be used together to attach a rear-facing or forward-facing child restraint?	No	Do not use the seat belt when you use the LATCH anchorage system to attach a rear-facing or forward-facing child restraint.
Can two child restraints be attached using a common lower LATCH anchorage?	No	Never “share” a LATCH anchorage with two or more child restraints. If the center position does not have dedicated LATCH lower anchorages, use the seat belt to install a child seat in the center position next to a child seat using the LATCH anchorages in an outboard position.
Can the rear-facing child restraint touch the back of the front passenger seat?	Yes	Contact between the front passenger seat and the child restraint is allowed, if the child restraint manufacturer also allows contact.
Can the head restraints be removed?	No	
Can the buckle stalk be twisted to tighten the seat belt against the belt path of the child restraint?	Yes	In positions with cinching latch plates (CINCH), the buckle stalk may be twisted up to 3 full turns. Do not twist the buckle stalk in a seating position with an ALR retractor.
2010-2013 Model Year Crew Cab, Full Bench Seat		
Can a child seat be installed in the center position using the inner LATCH lower anchorages?	No	Use the seat belt and tether anchor to install a child seat in the center seating position.

Center Seat LATCH

Crew Cab Full Bench (2010–2013 Model Years)

WARNING!

- Do not install a child restraint in the center position using the LATCH system. This position is not approved for installing child seats using the LATCH attachments. You must use the seat belt and tether anchor to install a child seat in the center seating position.
- Never use the same lower anchorage to attach more than one child restraint. Please refer to "Installing Child Restraints Using the LATCH Lower Anchorages" in the section "Installing Child Restraints" for typical installation instructions.

Crew Cab/Mega Cab Split Bench (2010–2013 Model Years)

If a child restraint installed in the center position blocks the seat belt webbing or buckle for the outboard position, do not use that outboard position. If a child seat in the center position blocks the outboard LATCH anchors or seat belt, do not install a child seat in that outboard position.

WARNING!

Never use the same lower anchorage to attach more than one child restraint. Please refer to "Installing Child Restraints Using the LATCH Lower Anchorages" in the section "Installing Child Restraints" for typical installation instructions.

Directions For Attaching The Tether Anchorage

Regular Cab/Mega Cab (2010–2013 Model Years)

In the regular cab truck, the top tether anchorages are located behind the center and right passenger seats. In the mega cab truck, the top tether anchorages are located behind each rear seating position. There is a plastic cover over each anchorage. To attach the tether strap of the child restraint:

1. Place the child restraint on the seat and adjust the tether strap so that it will reach over the seat back, under the head restraint and to the tether anchorage directly behind the seat.
2. Route the tether strap to provide the most direct path between the anchorage and the child seat. The tether strap should go between the head restraint posts underneath the head restraint. You may need to adjust the head restraint to the upward position to pass the tether strap underneath the head restraint and between its posts.

3. Lift the cover (if so equipped), and attach the hook to the square opening in the sheet metal.
4. Tighten the tether strap according to the child seat manufacturer's instructions.

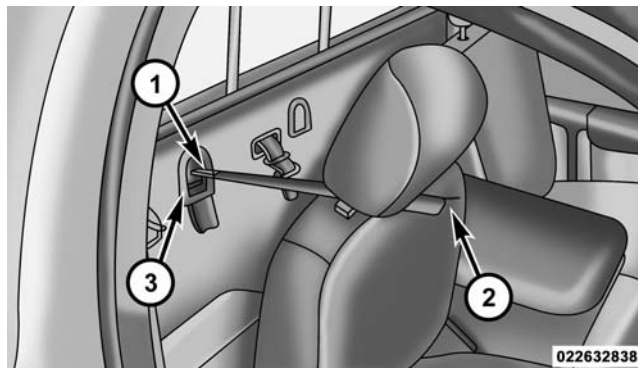

Regular Cab, Center And Right Front Seat
(2010-2013 Model Years)

1. Tether Strap Hook
2. Tether Strap To Child Restraint
3. Tether Anchorage

WARNING!

Never place a rear-facing child restraint in front of an air bag. A deploying passenger Advanced Front Air Bag can cause death or serious injury to a child 12 years or younger, including a child in a rear-facing child restraint.

Crew Cab (2010–2013 Model Years)

The top tether anchorages in this vehicle are tether strap loops located between the rear glass and the back of the rear seat. There is a tether strap loop located behind each seating position. Follow the steps below to attach the tether strap of the child restraint.

Right or Left Outboard Seats:

1. Raise the head restraint and reach between the rear seat and rear glass to access the tether strap loop.

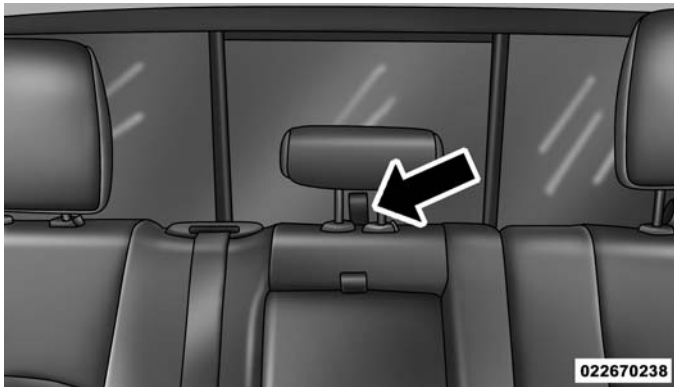

2. Place a child restraint on the seat and adjust the tether strap so that it will reach over the seat back, under the head restraint, through the tether strap loop behind the seat and over to the tether strap loop behind either the right or left outboard seat.
3. Attach the hook to the center tether strap loop (see diagram).

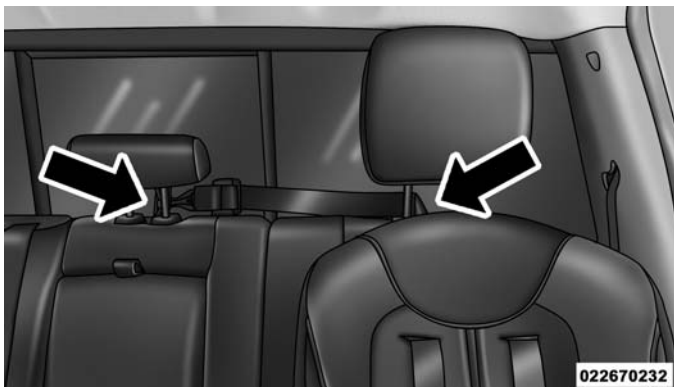

4. Tighten the tether strap according to the child seat manufacturer's instructions.

NOTE: If there are child seats in both of the outboard (left and right) seating positions, the tether strap hooks of both child seats should be connected to the center tether strap loop. This is the correct way to tether two outboard child seats.

Center Seat:

1. Raise the head restraint and reach between the rear seat and rear glass to access the tether strap loop.

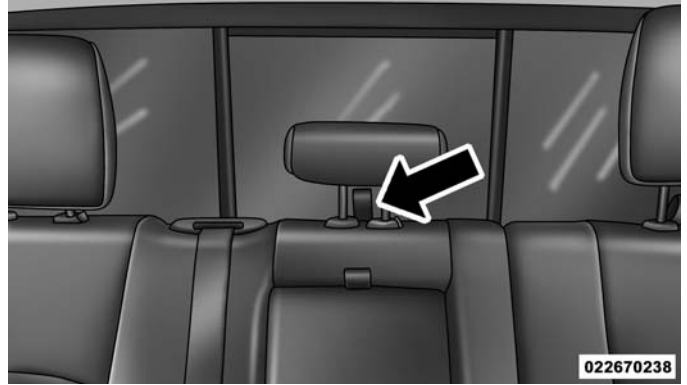

2. Place a child restraint on the seat and adjust the tether strap so that it will reach over the seat back, under the head restraint, through the tether strap loop behind the seat and over to the tether strap loop behind either the right or left outboard seat.
3. Pass the tether strap hook under the head restraint behind the child seat, through the tether strap loop behind the seat and over to the right or left outboard tether strap loop.

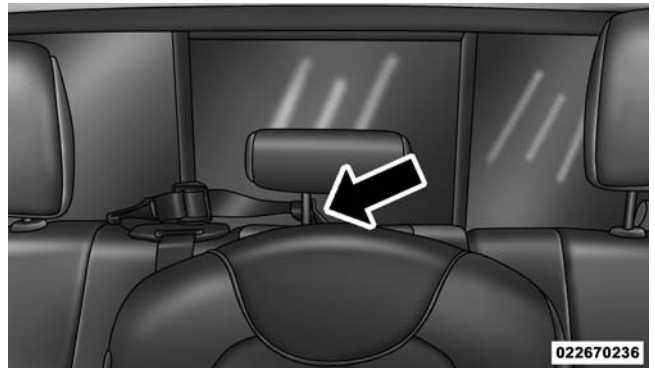

4. Attach the hook to the outboard tether strap loop (see diagram).

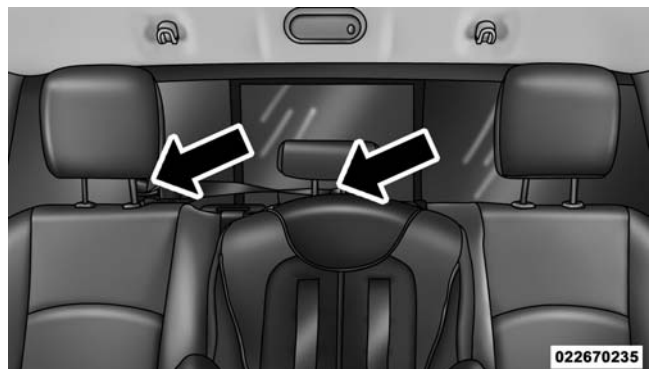

5. Tighten the tether strap according to the child seat manufacturer's instructions.

Installing Three Child Restraints:

1. Place a child restraint on each outboard rear seat. Route the tether straps following the directions for right and left seating positions, above.
2. Attach both hooks to the center tether strap loop, but do not tighten the straps yet.
3. Place a child restraint on the center rear seat. Route the tether strap following the directions for the center seating position, above.
4. Attach the hook to the outboard tether strap loop.
5. Tighten the tether straps according to the child seat manufacturer's instructions, tightening the right and left tether straps before the center tether strap.

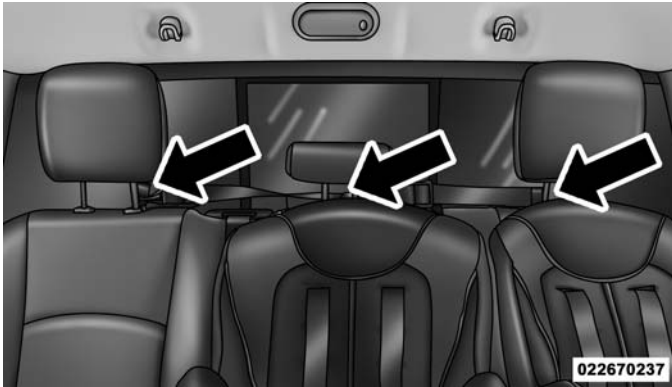
**WARNING!**

- An incorrectly anchored tether strap could lead to increased head motion and possible injury to the child. Use only the anchorage position directly behind the child seat to secure a child restraint top tether strap.
- If your vehicle is equipped with a split rear seat, make sure the tether strap does not slip into the opening between the seatbacks as you remove slack in the strap.

Seat Belt Systems In Your Vehicle

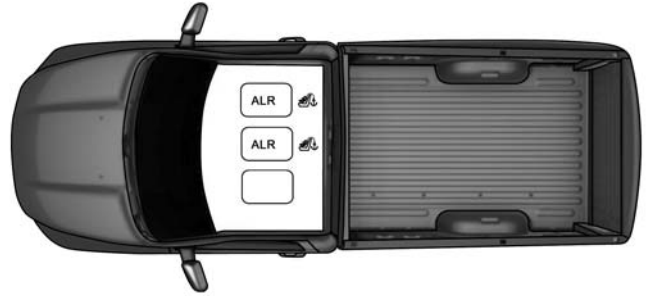

0226059225

Regular Cab (2010–2013 Model Years)

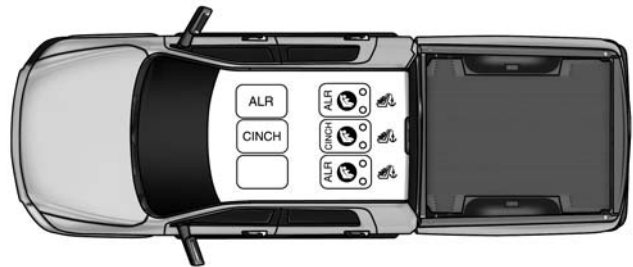

0226082963

Crew Cab/Mega Cab Split Bench Seat
(2010–2013 Model Years)

0226082962

Crew Cab Full Bench Seat (2010–2013 Model Years)

- ALR — Switchable Automatic Locking Retractor
- Lower Anchorage Symbol (2 Anchorages Per Seating Position)
- Top Tether Anchorage Symbol
- CINCH = Cinching Latch Plate

Frequently Asked Questions About Seat Belts And Car Seats

What is the weight limit (child’s weight + weight of the child restraint) for using the Tether Anchor with the seat belt to attach a forward facing child restraint?	Weight limit of the Child Restraint	Always use the tether anchor when using the seat belt to install a forward facing child restraint, up to the recommended weight limit of the child restraint.
Can the rear-facing child restraint touch the back of the front passenger seat?	Yes	Contact between the front passenger seat and the child restraint is allowed, if the child restraint manufacturer also allows contact.
Can the head restraints be removed?	No	
Can the buckle stalk be twisted to tighten the seat belt against the belt path of the child restraint?	Yes	In positions with cinching latch plates (CINCH), the buckle stalk may be twisted up to 3 full turns. Do not twist the buckle stalk in a seating position with an ALR retractor.

WARNING!

Do not install a rear-facing car seat using a rear support leg in this vehicle. The floor of this vehicle is not designed to manage the crash forces of this type of car seat. In a crash, the support leg may not function as it was designed by the car seat manufacturer, and your child may be more severely injured as a result.



0226047161

RAM CHASSIS CAB, 2011–2013

LATCH And Tethers In Your Vehicle

LATCH Positions For Installing Child Restraints In This Vehicle

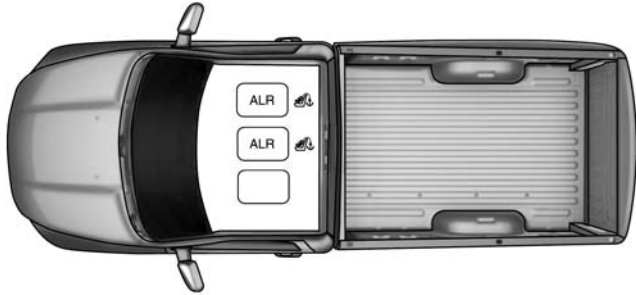

0226082977

Regular Cab (2011–2013 Model Years)

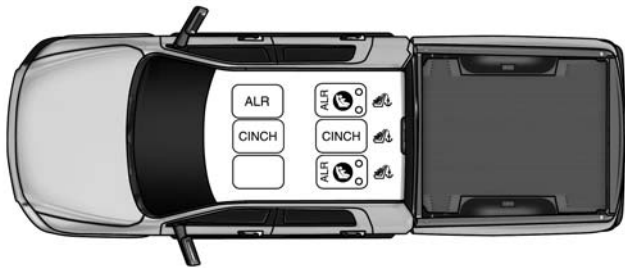

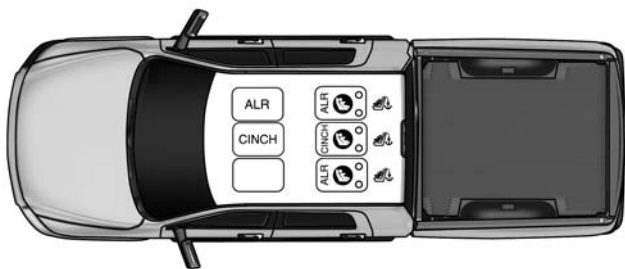

0226082978

Crew Cab Full Bench (2011–2013 Model Years)



0226082976

Crew Cab Split Bench (2011–2013 Model Years)

- ALR — Switchable Automatic Locking Retractor
- CINCH — Cinching Latch Plate
-  Lower Anchorage Symbol (2 Anchorages Per Seating Position)
-  Top Tether Anchorage Symbol

Locating The LATCH Lower Anchorages In This Vehicle

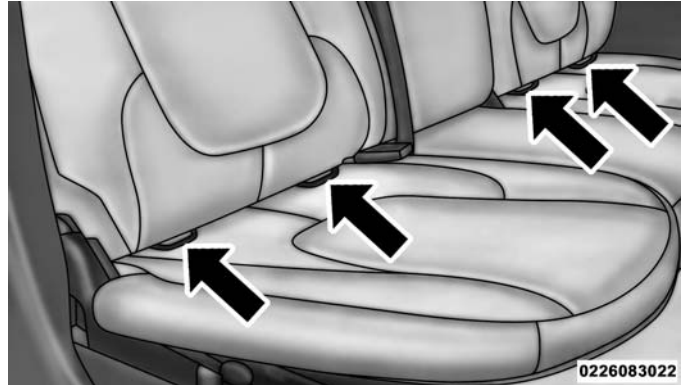

0226083022

Crew Cab Full Bench Anchorages (2011–2013 Model Years)

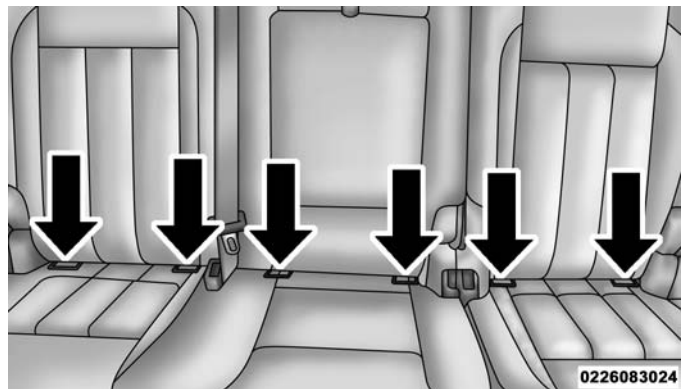

0226083024

Crew Cab Split Bench Anchorages (2011–2013 Model Years)

Locating The Tether Anchorages In This Vehicle



Regular Cab models have tether strap anchorages behind the front center and right seats. Crew Cab models have tether strap anchorages located behind each of the rear seats.

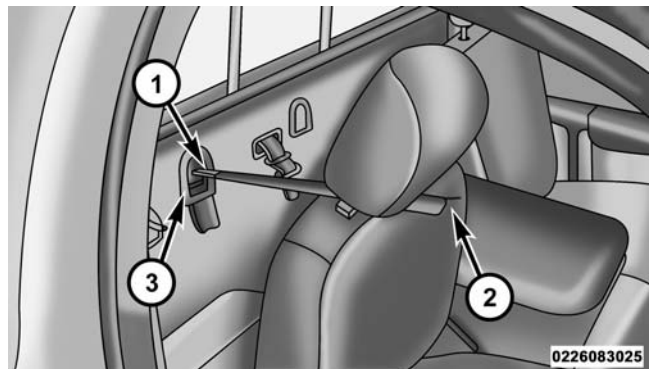

0226083025

Regular Cab, Center & Right Front Seat (2011-2013 Model Years)

1. Tether Strap Hook
2. Tether Strap To Child Restraint
3. Tether Anchorage



Crew Cab Rear Outboard Tether Anchorage
(2011-2013 Model Years)

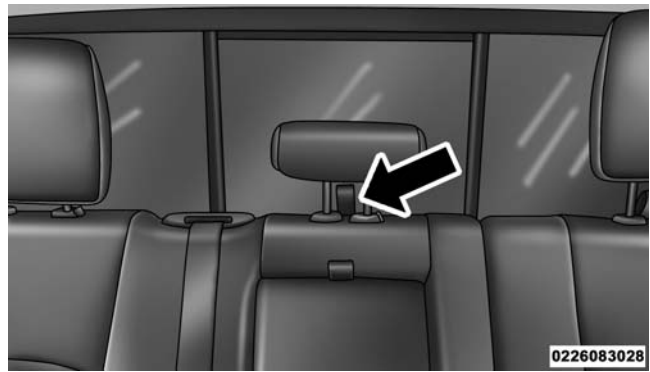

Crew Cab Rear Center Tether Anchorage
(2011-2013 Model Years)

Frequently Asked Questions About LATCH

What is the weight limit (child’s weight + weight of the child restraint) for using the LATCH anchorage system to attach the child restraint?	65 lbs (29.5 kg)	Use the LATCH anchorage system until the combined weight of the child and the child restraint is 65 lbs (29.5 kg). Use the seat belt and tether anchor instead of the LATCH system once the combined weight is more than 65 lbs (29.5 kg).
Can the LATCH anchorages and the seat belt be used together to attach a rear-facing or forward-facing child restraint?	No	Do not use the seat belt when you use the LATCH anchorage system to attach a rear-facing or forward-facing child restraint.
Can two child restraints be attached using a common lower LATCH anchorage?	No	Never “share” a LATCH anchorage with two or more child restraints. If the center position does not have dedicated LATCH lower anchorages, use the seat belt to install a child seat in the center position next to a child seat using the LATCH anchorages in an outboard position.
Can the rear-facing child restraint touch the back of the front passenger seat?	Yes	The child seat may touch the back of the front passenger seat if the child restraint manufacturer also allows contact. See your child restraint owner’s manual for more information.
Can the head restraints be removed?	No	
2011–2013 Crew Cab Full Bench		
Can a child seat be installed in the center position using the inner LATCH lower anchorages?	No	Use the seat belt and tether anchor to install a child seat in the center seating position.

Center Seat LATCH

Crew Cab Full Bench (2011–2013 Model Years)

WARNING!

- Do not install a child restraint in the center position using the LATCH system. This position is not approved for installing child seats using the LATCH attachments. You must use the seat belt and tether anchor to install a child seat in the center seating position.
- Never use the same lower anchorage to attach more than one child restraint. Please refer to “Installing Child Restraints Using the LATCH Lower Anchorages” in the section “Installing Child Restraints” for typical installation instructions.

Crew Cab Split Bench (2011–2013 Model Years)

If a child restraint installed in the center position blocks the seat belt webbing or buckle for the outboard position, do not use that outboard position. If a child seat in the center position blocks the outboard LATCH anchors or seat belt, do not install a child seat in that outboard position.

WARNING!

Never use the same lower anchorage to attach more than one child restraint. Please refer to “Installing Child Restraints Using the LATCH Lower Anchorages” in the section “Installing Child Restraints” for typical installation instructions.

Directions For Attaching The Tether Anchorage:**Regular Cab (2011–2013 Model Years)**

In the regular cab truck, the top tether anchorages are located behind the center and right passenger seats. There is a plastic cover over each anchorage. To attach the tether strap of the child restraint:

1. Place the child restraint on the seat and adjust the tether strap so that it will reach over the seat back, under the head restraint and to the tether anchorage directly behind the seat.
2. Route the tether strap to provide the most direct path between the anchorage and the child seat. The tether strap should go between the head restraint posts underneath the head restraint. You may need to adjust the head restraint to the upward position to pass the tether strap underneath the head restraint and between its posts.
3. Lift the cover (if so equipped), and attach the hook to the square opening in the sheet metal.
4. Tighten the tether strap according to the child seat manufacturer's instructions.

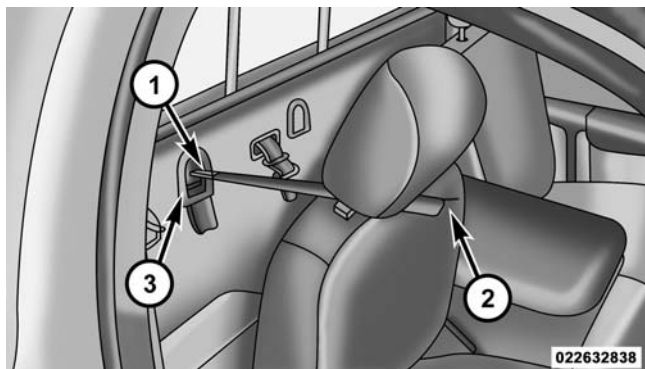

**Regular Cab, Center And Right Front Seat
(2011-2013 Model Years)**

1. Tether Strap Hook
2. Tether Strap To Child Restraint
3. Tether Anchorage

WARNING!

Never place a rear-facing child restraint in front of an air bag. A deploying passenger Advanced Front Air Bag can cause death or serious injury to a child 12 years or younger, including a child in a rear-facing child restraint.

Crew Cab (2011–2013 Model Years)

The top tether anchorages in this vehicle are tether strap loops located between the rear glass and the back of the rear seat. There is a tether strap loop located behind each seating position. Follow the steps below to attach the tether strap of the child restraint.

Right or Left Outboard Seats:

1. Raise the head restraint and reach between the rear seat and rear glass to access the tether strap loop.



2. Place a child restraint on the seat and adjust the tether strap so that it will reach over the seat back, under the head restraint, through the tether strap loop behind the seat and over to the tether strap loop behind the center seat.

3. Attach the tether strap hook to the center tether strap loop (see diagram).

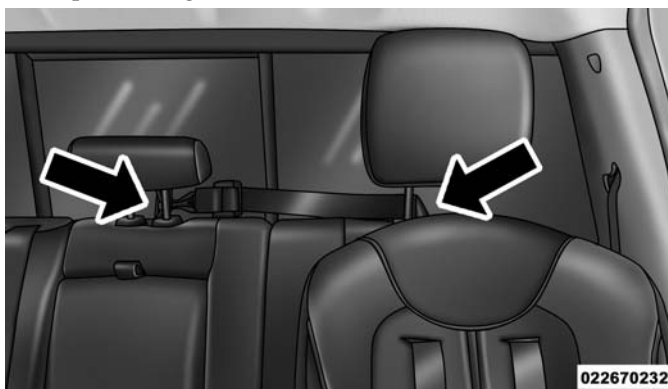

4. Tighten the tether strap according to the child seat manufacturer's instructions.

NOTE: If there are child seats in both of the outboard (left and right) seating positions, the tether strap hooks of both child seats should be connected to the center tether strap loop. This is the correct way to tether two outboard child seats.

Center Seat:

1. Raise the head restraint and reach between the rear seat and rear glass to access the tether strap loop.

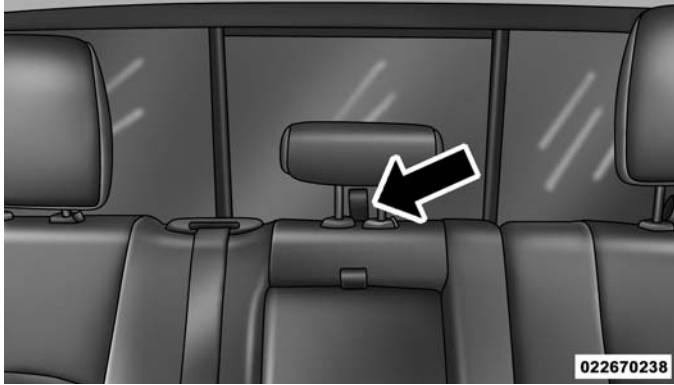

2. Place a child restraint on the seat and adjust the tether strap so that it will reach over the seat back, under the head restraint, through the tether strap loop behind the seat and over to the tether strap loop behind either the right or left outboard seat.
3. Pass the tether strap hook under the head restraint behind the child seat, through the tether strap loop behind the seat and over to the right or left outboard tether strap loop.

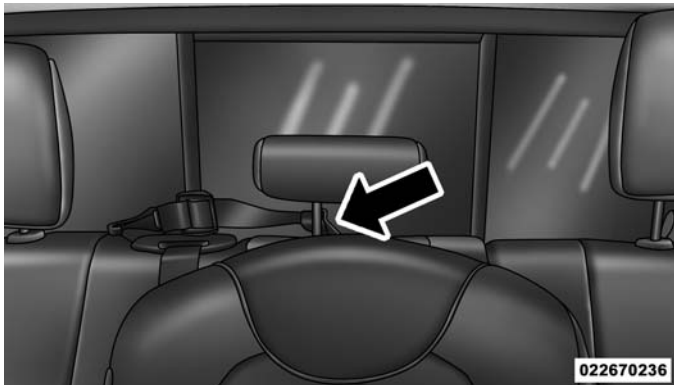

4. Attach the tether strap hook to the outboard tether strap loop (see diagram).

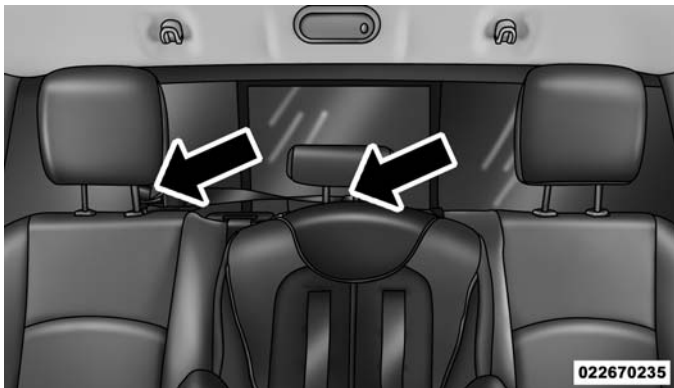

5. Tighten the tether strap according to the child seat manufacturer's instructions.

Installing Three Child Restraints:

1. Place a child restraint on each outboard rear seat. Route the tether straps following the directions for right and left seating positions, above.
2. Attach both tether strap hooks to the center tether strap loop, but do not tighten the straps yet.
3. Place a child restraint on the center rear seat. Route the tether strap following the directions for the center seating position, above.
4. Attach the tether strap hook to the outboard tether strap loop.
5. Tighten the tether straps according to the child seat manufacturer's instructions, tightening the right and left tether straps before the center tether strap.

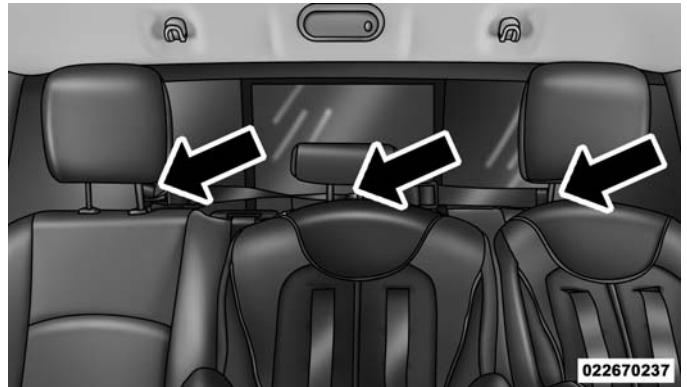

WARNING!
<ul style="list-style-type: none"> • An incorrectly anchored tether strap could lead to increased head motion and possible injury to the child. Use only the anchorage position directly behind the child seat to secure a child restraint top tether strap. • If your vehicle is equipped with a split rear seat, make sure the tether strap does not slip into the opening between the seatbacks as you remove slack in the strap.

Seat Belt Systems In Your Vehicle

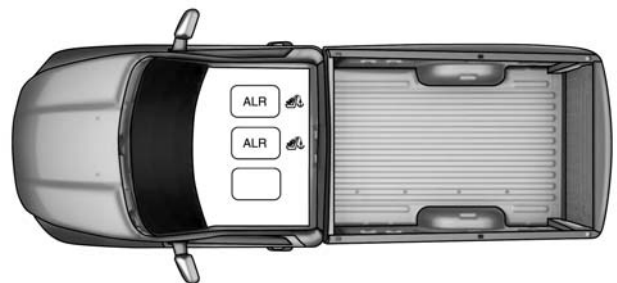

Regular Cab (2011–2013 Model Years)

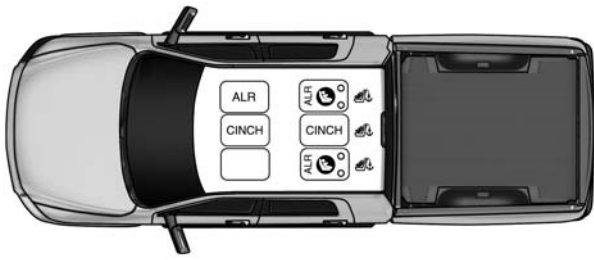

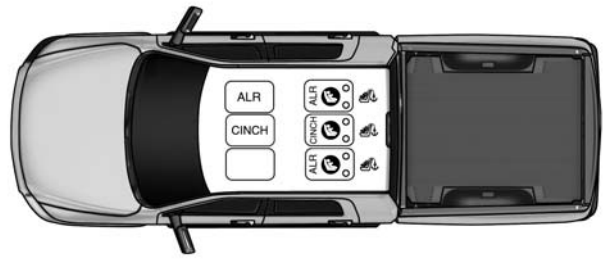

0226082978

Crew Cab Full Bench (2011–2013 Model Years)



0226082976

Crew Cab Split Bench (2011–2013 Model Years)

- ALR — Switchable Automatic Locking Retractor
- CINCH — Cinching Latch Plate
-  Lower Anchorage Symbol (2 Anchorages Per Seating Position)
-  Top Tether Anchorage Symbol

Frequently Asked Questions About Seat Belts And Car Seats

What is the weight limit (child’s weight + weight of the child restraint) for using the Tether Anchor with the seat belt to attach a forward facing child restraint?	Weight limit of the Child Restraint	Always use the tether anchor when using the seat belt to install a forward facing child restraint, up to the recommended weight limit of the child restraint.
Can the rear-facing child restraint touch the back of the front passenger seat?	Yes	Contact between the front passenger seat and the child restraint is allowed, if the child restraint manufacturer also allows contact.
Can the head restraints be removed?	No	
Can the buckle stalk be twisted to tighten the seat belt against the belt path of the child restraint?	Yes	In positions with cinching latch plates (CINCH), the buckle stalk may be twisted up to 3 full turns. Do not twist the buckle stalk in a seating position with an ALR retractor.

WARNING!

Do not install a rear-facing car seat using a rear support leg in this vehicle. The floor of this vehicle is not designed to manage the crash forces of this type of car seat. In a crash, the support leg may not function as it was designed by the car seat manufacturer, and your child may be more severely injured as a result.



0226047161

INDEX

- Automatic Locking Retractor (ALR) 7
- Center Seat LATCH 7, 13, 20, 28, 39, 46, 52, 58, 63
- Child Restraints 5
- Frequently Asked Questions About
 - LATCH 11, 18, 26, 37, 45, 51, 56, 62
- Frequently Asked Questions About Seat Belts
 - And Car Seats. 15, 22, 33
- How To Stow An Unused ALR Seat Belt. 7
- Installing A Child Restraint With A Cinching
 - Latch Plate. 7
- Installing A Child Restraint With ALR 7
- Installing Child Restraints In Your Vehicle 1, 10, 51
- Installing Child Restraints Using The LATCH Lower
 - Anchorage 6
- Installing Child Restraints Using The Top Tether
 - Anchorage 8
- Installing Child Restraints Using The Vehicle Seat Belt. . . 7
- LATCH And Tethers In Your
 - Vehicle 10, 17, 24, 36, 44, 51, 56, 62
 - LATCH Lower Anchorages. . . . 11, 18, 25, 37, 45, 51, 56, 62
- Locating The LATCH And Tether
 - Anchorage 6, 11, 18, 25, 37, 45, 51, 56, 62
- Lower Anchors And Tether For Children (LATCH). 6
- Rear Facing Car Seats And Air Bags. 5
- Seat Belt Systems In Your Vehicle. 15, 22, 33
- Top Tether Anchorages 8, 11, 18, 26, 37, 45, 51, 56, 62

